

At Sea



Putting safety first



Safety above all

DISCLAIMER

The author and publisher of this catalogue intend that this catalogue contain only general discussions and information; it is not intended to be comprehensive or to address all the possible contexts and situations involving the products and processes described herein. This catalogue is designed for generic study or research use only and is not a substitute for specific training or experience when utilizing the products and processes discussed herein. Nor is this catalogue intended to serve as a substitute for any proper training and/or certification needed for operation of the products and processes described herein. Accordingly, this catalogue is meant to be advisory and is not intended for specific application. Each application of the products and/or processes described herein may differ and the specifics involved must be addressed separately and individually depending on your situation.

MCT Brattberg (the "Company") assumes no liability for any use of or reliance upon any material contained or referenced in this catalogue; the use of this catalogue is at your own risk. THE COMPANY MAKES NO WARRANTIES, EXPRESS OR IMPLIED, INCLUDING WARRANTIES AS TO MERCHANTABILITY, AS TO THE FITNESS OF THE CATALOGUE OR ITS CONTENTS FOR ANY PARTICULAR USE OR PURPOSE, NON-INFRINGEMENT, OR AS TO THE ACCURACY, APPLICABILITY, OR COMPLETENESS OF THE CONTENTS OF THE CATALOGUE, AND SHALL NOT BE LIABLE FOR ANY LOSS OR DAMAGE, DIRECTLY OR INDIRECTLY, ARISING FROM THE USE OF SUCH CATALOGUE OR FOR CONSEQUENTIAL DAMAGES. In no event shall Company be liable for: (a) punitive, incidental or consequential damages arising out of the use of the information from this catalogue, including, but not limited to, damage to persons or property, loss of use, loss of time, inconvenience, equipment rental, loss of earnings or profits, loss of business opportunities, or any other commercial loss, or (b) any losses, claims, damages, expenses, liabilities or costs (including legal fees) resulting directly or indirectly from use of the material in this CATALOGUE, WHICH IS PROVIDED "AS IS," AND WITHOUT WARRANTIES. The conditions in this paragraph apply to any acts, omissions and negligence of Company that would give rise to a course of legal action. The reader hereby agrees to indemnify and hold harmless Company its officers, directors, shareholders, employees, agents, subsidiaries, affiliates, parent companies and successors in interest against all claims and expenses (including attorney fees) arising from the use of any information in the catalogue. Further, Company is not responsible for any warranties of any nature made by any representative or agent that have not also been agreed to in writing by an officer of the Company.











364 - 388174v1
056390/000001

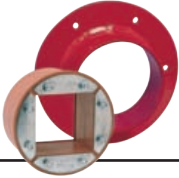

Contents

Certification and testing	Page 4
The MCT Brattberg Safety Club	Page 5
The original cable transit	Page 6
Special seals	Page 7

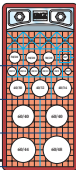
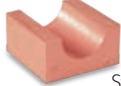
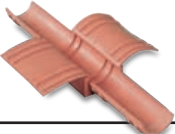
Productprogramme

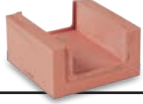
	RGS Pages 8-9		RGSF Pages 10-11		RGSC Pages 12-13		
	RGSK/RGSbtb Pages 14-16		RGSR Page 17		Multiple Frames Page 17		
	RGP Pages 18-19		Accessories Pages 20-21		Planning Pages 22-25		Standard insert Blocks Pages 26-27
	AddBlocks Page 28		Plugs Page 29		U-Blocks Pages 30-31		

Installation

Welding instructions	Pages 32-33
Insulation	Pages 34-35
Installation guide	Pages 36-37
Addresses	Page 40

Tested, approved and certified



Since the early 1950s, when we first started specializing in fireproof and pressure-sealed transits, quality testing and classification has been essential.

In 1986 our sealing method and quality system was adapted to meet the rigid requirements of the offshore industry. Today MCT Brattberg is assessed and certified by DNV, in accordance with the Quality and Environment Management system standard EN ISO 9001 and 14001, for the design, manufacture and supply of fire barrier and sealed transit systems associated with cable and pipe routes in building and marine environments.

As a direct result of this achievement, quality and environmental assessments are carried out by DNV twice annually.

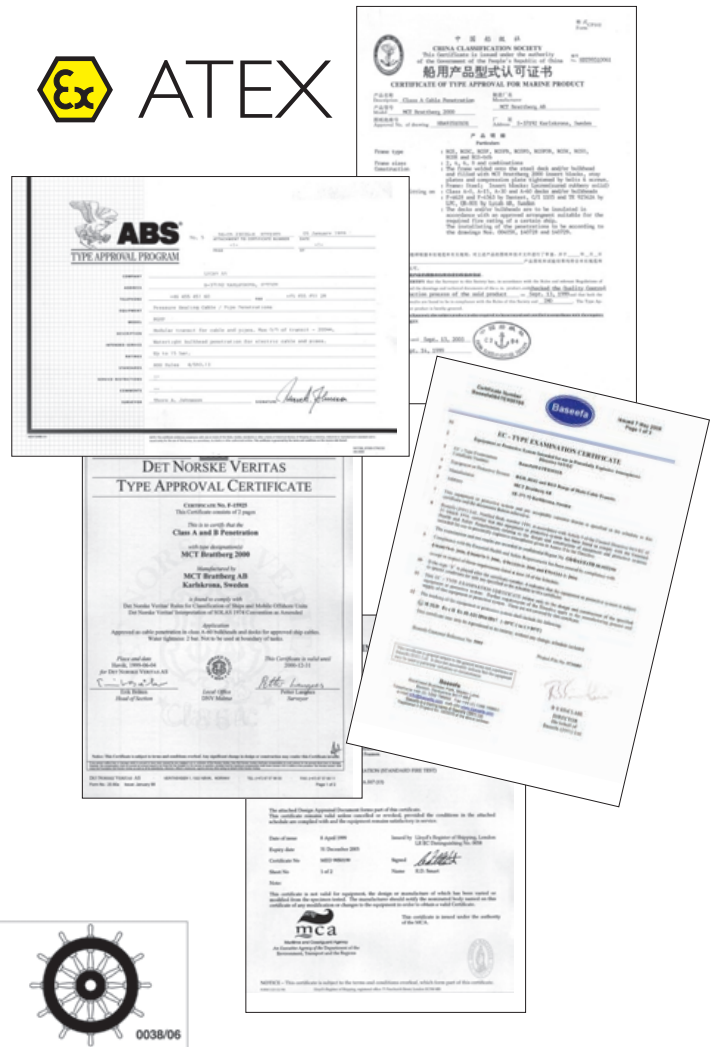

Our products are tested and certified by a long list of customers, laboratories and certification organizations.

- ABS, American Bureau of Shipping - Canadian Coast Guard - Bureau Veritas
 - China Classification Society - Australian Maritime Safety Authority - DNV, Det Norske Veritas
 - Korean Register of Shipping - Lloyds' Register of Shipping - Nippon Kaiji Kyokai
 - Polski Rejestr Statkow - Germanischer Lloyd - Swedish Adm. of Shipping and Navigation
 - Croatian Register of Shipping - RINA, Registro Italiano Navale
 - Russian Maritime Register - US Coast Guard - US Navy - Underwriters Laboratories Inc. Underwriters Laboratories of Canada
 - MCT Brattberg is also certified according to MED, Marine Equipment Directive (via Lloyds' Register of Shipping)
- Please consult MCT Brattberg for latest updated certificates and approvals.

The MCT Brattberg Safety Club

This club is located on our website at: www.mctbrattberg.com. First click on the menu header *Putting safety first* and then *The MCT Safety Club*. Its content primarily present information that will help those who install our cable and transit to do it correctly in order to achieve a high standard of safety. The first time you visit the club you will be required to register. After that you can log in when you want and download material, see installation films or access various online training modules.

Hyperlinks embedded in the website club give you direct access to:

Presentation of Transit design RG Plan

- Planning the packing space
- Transit installation
- Online training modules



The original cable transit

Based on the simple but clever idea of a frame with insert blocks and an end seal, the MCT Brattberg is the original transit system.

The MCT Brattberg was patented in the early 1950s. When oil rigs and nuclear power stations demanded cable and pipe installations with proven safety records, the MCT Brattberg system became a worldwide solution. And we've been improving it ever since. Comprehensive documentation shows that its resistance to fire, water, gas and pressure meets the latest safety requirements.

The industry standard

Our own experience has shown that for a standard frame used for maritime applications, an internal width of 120.5 mm \pm 0.5 mm, a depth of 60 mm and wall thickness of 10 mm are optimal window sizes for maintaining structural strength and for fitting insert blocks. The welded corners are rounded for added strength. Both single and multiple transits frames are available.

The dimensions of the various frames have become the industry standard simply because these types of frames were first to be introduced and have proved successful over time.

Built in flexibility

The comprehensive range of frames, inserts blocks and other components of our transits provides remarkable application flexibility.

In addition, our product range covers insulation collars and special solutions for EMC transits, SR cable and pipe seals, deck and bulkhead glands.

- Frames
- Standard insert blocks
- Add Blocks
- U-blocks
- Spare blocks
- Components
- Accessories



Special products for special uses

MCT Brattberg manufactures a number of special products. High pressure secure cable transits, transits for wave guides and blocks with built-in protection against electromagnetic pulse due to lightning or nuclear blast.

High pressure seals and blocks for wave guides

are two examples of our special products. Several types of high pressure seals are available. Often these have been designed in collaboration with a customer. They are used, for example, in the supporting legs of oil rigs or in submarines. An example is the RGPH seal, which has been tested up to 100 bar.

Blocks for oval wave guides are also manufactured to order. These fit all Brattberg frames and are used mainly in radar stations.

The E-series frames

and components provide the same protection as the standard MCT Brattberg system but with added, built-in protection against electromagnetic pulses caused by lightning or nuclear blast.

They also give protection against interference, electronic sabotage (synthetic EMP) and static electricity.

All dimensions are exactly the same as for the other MCT Brattberg components.

ATEX and IECEx certified transits

In explosion hazardous environments, it's important to have Ex equipment. MCT Brattberg has a specific program for this areas with products that are tested and certified according to the ATEX directive 94/9/EC and the international IECEx. All dimensions are exactly the same as for the other MCT Brattberg components.

For special products please consult MCT Brattberg.

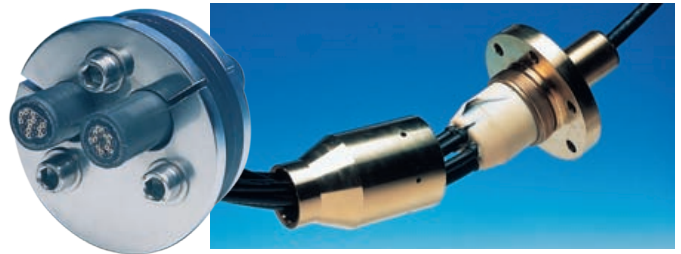

PHP pressure hull penetrator for submarines.

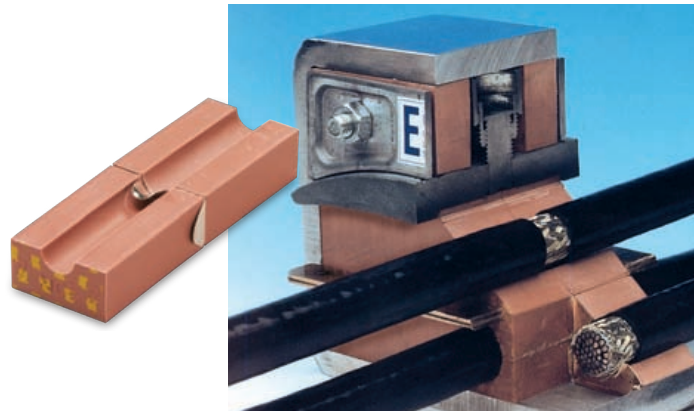

Products to protect against EMC.

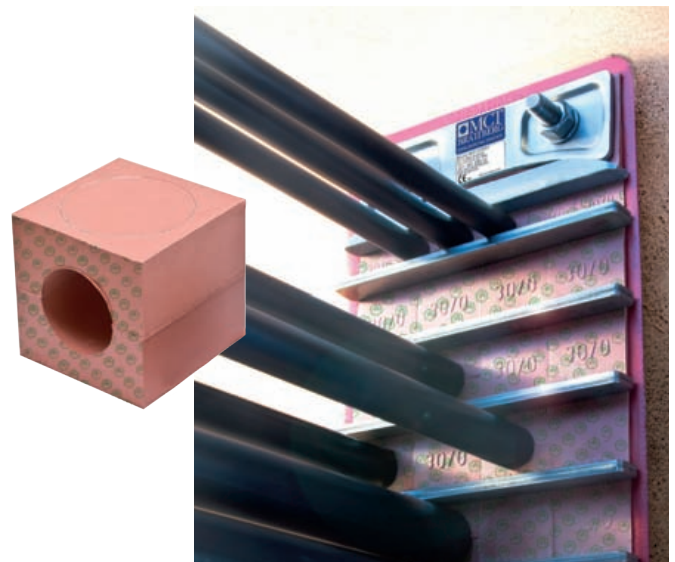

RGS

RGSO WITH REMOVABLE END

RGS is MCT Brattberg's standard frame for marine applications. It has a standard internal width of 120 mm and is 60 mm deep. There are four sizes of RGS, denoted by 2, 4, 6 and 8 depending on their height. They may be used in both vertical and/or horizontal multiple frames.

The RGS is welded into an accurately pre-cut hole in the deck or bulkhead. As with all our frames, RGS is produced in steel, stainless steel, or aluminium. For installations where cables are already in place, specify RGSO, which has a removable end. RGS weight charts can be found on the next page.

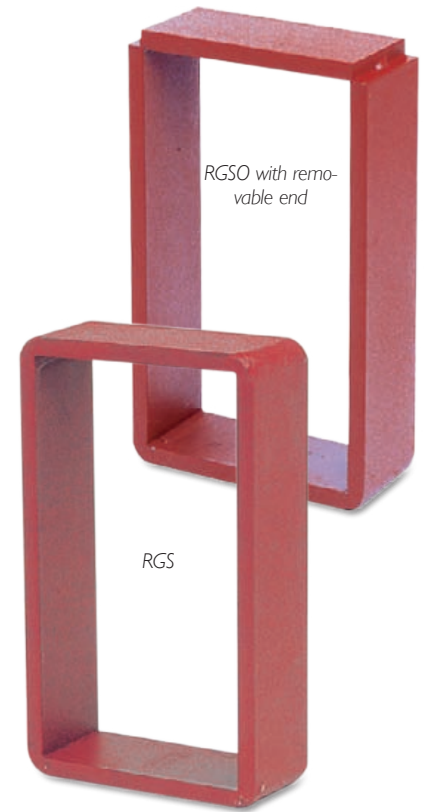

Size in mm									
FRAME SIZE	H (height)	W (width)/Multiple Frames							
		x 1	x 2	x 3	x 4	x 5	x 6	x n	
RGS-2	121	140,5	271	401,5	532	662,5	793	W = 10 + 130,5 x n	
RGS-4	179,5	- " -	- " -	- " -	- " -	- " -	- " -		
RGS-6	238	- " -	- " -	- " -	- " -	- " -	- " -		
RGS-8	296,5	- " -	- " -	- " -	- " -	- " -	- " -		
RGS-2+2	242	n = number of frames wide. Tolerance single frame: Height ± 1 mm, Width ± 0,8 mm. Material thickness is 10 mm.	- " -	- " -	- " -	- " -	- " -		
RGS-2+4	300,5		- " -	- " -	- " -	- " -	- " -		
RGS-2+6	359		- " -	- " -	- " -	- " -	- " -		
RGS-2+8	417,5		- " -	- " -	- " -	- " -	- " -		
RGS-4+4	359		- " -	- " -	- " -	- " -	- " -		
RGS-4+6	417,5		- " -	- " -	- " -	- " -	- " -		
RGS-4+8	476		- " -	- " -	- " -	- " -	- " -		
RGS-6+6	476		- " -	- " -	- " -	- " -	- " -		
RGS-6+8	534,5		- " -	- " -	- " -	- " -	- " -		
RGS-8+8	593		- " -	- " -	- " -	- " -	- " -		
RGS-2+2	232		140,5	All measurements are in millimeters.					
RGS-2+4	290,5		- " -						
RGS-2+6	349		- " -						
RGS-2+8	407,5		- " -						
RGS-4+4	349		- " -						
RGS-4+6	407,5		- " -						
RGS-4+8	466	- " -							
RGS-6+6	466	- " -							
RGS-6+8	524,5	- " -							
RGS-8+8	583	- " -							

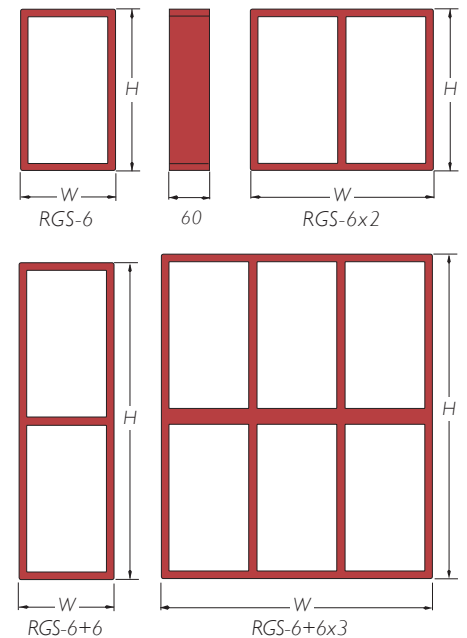

RGS

WEIGHT CHART

Standard frames come in four sizes: 2, 4, 6 and 8. They are all the same width. Height differences are shown below. The material is 10 mm thick.

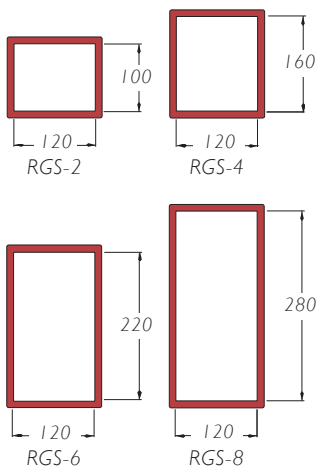

Weight in kilograms								
MATERIAL	FRAME SIZE	W (width)/Multiple Frames						
		x 1	x 2	x 3	x 4	x 5	x 6	
MILD STEEL EN10025-2 S355JR 1.0045 A36	RGS-2	2,2	3,9	5,7	7,4	9,2	10,9	
	RGS-4	2,7	4,6	6,5	8,4	10,3	12,2	
	RGS-6	3,2	5,4	7,6	9,8	12,0	14,2	
	RGS-8	3,8	6,3	8,9	11,4	14,0	16,5	
	RGS-2+2	3,6	8,1	11,9	15,7	19,5	23,3	
	RGS-2+4	4,2	8,8	12,8	16,7	20,7	24,6	
	RGS-2+6	4,8	9,5	13,6	17,8	21,9	26,0	
	RGS-2+8	5,5	10,3	14,7	19,1	23,5	27,9	
	RGS-4+4	4,8	9,5	13,6	17,8	21,9	26,0	
	RGS-4+6	5,5	10,3	14,7	19,1	23,5	27,9	
	RGS-4+8	5,9	11,1	15,8	20,5	25,1	29,8	
	RGS-6+6	5,9	11,1	15,8	20,5	25,1	29,8	
	RGS-6+8	6,5	12,0	17,0	22,1	27,1	32,1	
	RGS-8+8	7,2	12,9	18,3	23,7	29,1	34,5	
	STAINLESS STEEL EN 10088-2 1.4404 AISI 316L	RGS-2	2,2	4,0	5,8	7,6	9,4	11,2
		RGS-4	2,8	4,7	6,7	8,6	10,6	12,6
RGS-6		3,3	5,5	7,8	10,0	12,3	14,5	
RGS-8		3,9	6,5	9,1	11,7	14,3	16,9	
RGS-2+2		3,7	8,3	12,2	16,1	20,0	23,9	
RGS-2+4		4,3	9,0	13,1	17,1	21,2	25,2	
RGS-2+6		4,9	9,7	14,0	18,2	22,5	26,7	
RGS-2+8		5,6	10,6	15,1	19,6	24,1	28,6	
RGS-4+4		4,9	9,7	14,0	18,2	22,5	26,7	
RGS-4+6		5,6	10,6	15,1	19,6	24,1	28,6	
RGS-4+8		6,0	11,4	16,2	21,0	25,8	30,6	
RGS-6+6		6,0	11,4	16,2	21,0	25,8	30,6	
RGS-6+8		6,7	12,3	17,5	22,6	27,8	32,9	
RGS-8+8		7,4	13,2	18,8	24,3	29,9	35,4	
ALUMINIUM EN 755-2 EN AW-6082		RGS-2	0,8	1,4	2,0	2,6	3,2	3,8
		RGS-4	1,0	1,6	2,3	3,0	3,6	4,3
	RGS-6	1,1	1,9	2,7	3,4	4,2	5,0	
	RGS-8	1,3	2,2	3,1	4,0	4,9	5,8	
	RGS-2+2	1,3	2,8	4,2	5,5	6,9	8,2	
	RGS-2+4	1,5	3,1	4,5	5,9	7,2	8,6	
	RGS-2+6	1,7	3,3	4,8	6,2	7,7	9,1	
	RGS-2+8	1,9	3,6	5,2	6,7	8,3	9,8	
	RGS-4+4	1,7	3,3	4,8	6,2	7,7	9,1	
	RGS-4+6	1,9	3,6	5,2	6,7	8,3	9,8	
	RGS-4+8	2,1	3,9	5,5	7,2	8,8	10,4	
	RGS-6+6	2,1	3,9	5,5	7,2	8,8	10,4	
	RGS-6+8	2,3	4,2	6,0	7,7	9,5	11,2	
	RGS-8+8	2,5	4,5	6,4	8,3	10,2	12,1	

RGSF/RGSFB

RGSFO/RGSFBO WITH REMOVABLE END

RGSF is a standard RGS frame with a flange that allows the frame to be welded into a hole which is slightly larger than the frame.

RGSF comes in the four standard sizes, 2, 4, 6 and 8, and has the standard measurements of the RGS, but with the added width of the flange: 60 mm wide and 10 mm thick. RGSF can also be installed in multiple frames, see page 17.

For installations where cables are already in place, specify RGSFO which has a removable end.

The **RGSFB** frame is similar to RGSF except that it is bolted to the deck or bulkhead. The bolted frames can be used in areas where hot working is prohibited, or when the stress level induced by welding is unacceptable. RGSFB frames are supplied in kit form, complete with drilled holes, bolts, nuts, washers and a gasket or sealing compound. The latter to be installed between the flange and the deck or bulk-head to ensure a gas-tight in-stallation. The standard sizes and weights are the same as for RGSF.

For installations where cables are already in place, specify RGSFBO which has a bolted removable end.

Size in mm								
FRAME SIZE	H (height)	W (width)/Multiple Frames						
		x 1	x 2	x 3	x 4	x 5	x 6	x n
RGSF/B-2	241	260,5	391	521.5	652	782.5	913	W = 130+
RGSF/B-4	299,5	- " -	- " -	- " -	- " -	- " -	- " -	130,5 x n
RGSF/B-6	358	- " -	- " -	- " -	- " -	- " -	- " -	
RGSF/B-8	416,5	- " -	- " -	- " -	- " -	- " -	- " -	
RGSF/B-2+2	362	- " -	- " -	- " -	- " -	- " -	- " -	
RGSF/B-2+4	420,5	- " -	- " -	- " -	- " -	- " -	- " -	
RGSF/B-2+6	479	- " -	- " -	- " -	- " -	- " -	- " -	
RGSF/B-2+8	537,5	- " -	- " -	- " -	- " -	- " -	- " -	
RGSF/B-4+4	479	- " -	- " -	- " -	- " -	- " -	- " -	
RGSF/B-4+6	537,5	- " -	- " -	- " -	- " -	- " -	- " -	
RGSF/B-4+8	596	- " -	- " -	- " -	- " -	- " -	- " -	
RGSF/B-6+6	596	- " -	- " -	- " -	- " -	- " -	- " -	
RGSF/B-6+8	654,5	- " -	- " -	- " -	- " -	- " -	- " -	
RGSF/B-8+8	713	- " -	- " -	- " -	- " -	- " -	- " -	
RGSF/B-2+2	352	260,5	n = number of frames wide. Tolerance single frame: Height ± 1 mm, Width ± 0,8 mm. Material thickness is 10 mm. RGSF-frames are normally supplied with straight corners but are also available with round corners with a radius of 63 mm.					
RGSF/B-2+4	410,5	- " -						
RGSF/B-2+6	469	- " -						
RGSF/B-2+8	527,5	- " -						
RGSF/B-4+4	469	- " -						
RGSF/B-4+6	527,5	- " -						
RGSF/B-4+8	586	- " -						
RGSF/B-6+6	586	- " -						
RGSF/B-6+8	644,5	- " -						
RGSF/B-8+8	703	- " -						

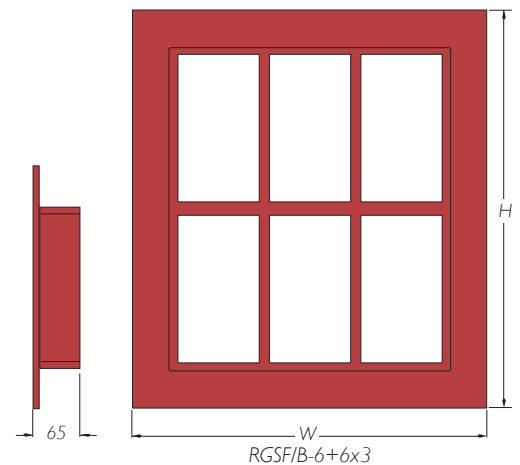
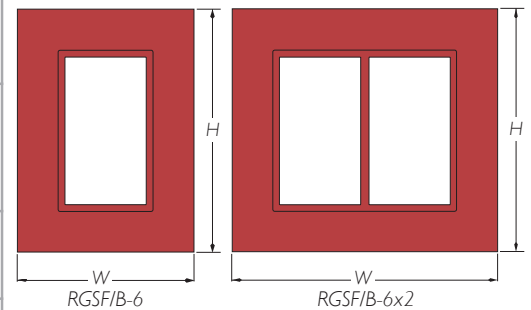



Standard frames come in four sizes: 2, 4, 6 and 8. They are all the same width. Height differences are shown below. The material is 10 mm thick.

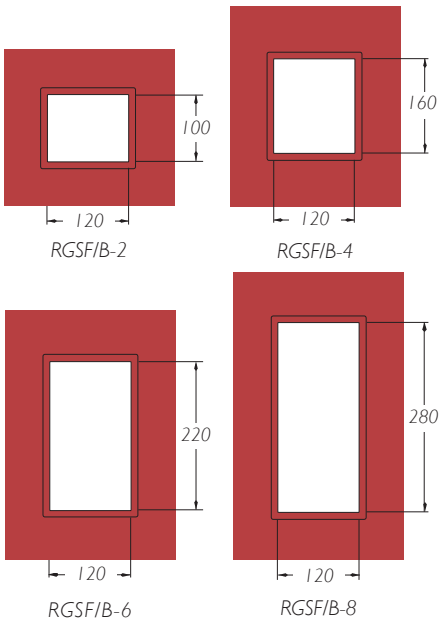

Weight chart in kilograms

Weight in kilograms							
MATERIAL	FRAME SIZE	W (width)/Multiple Frames					
		x 1	x 2	x 3	x 4	x 5	x 6
MILD STEEL EN10025-2 S355JR I.0045 A36	RGSF/B-2	5,9	8,9	11,8	14,8	17,8	20,7
	RGSF/B-4	7,0	10,3	13,6	16,9	20,2	23,4
	RGSF/B-6	8,0	11,5	15,1	18,6	22,1	25,6
	RGSF/B-8	9,0	12,8	16,5	20,3	24,0	27,8
	RGSF/B-2+2	8,4	13,9	19,0	24,0	29,1	34,1
	RGSF/B-2+4	9,5	15,3	20,5	25,7	30,9	36,1
	RGSF/B-2+6	10,6	16,5	21,9	27,2	32,6	37,9
	RGSF/B-2+8	11,7	17,9	23,5	29,2	34,8	40,4
	RGSF/B-4+4	10,6	16,5	21,9	27,2	32,6	37,9
	RGSF/B-4+6	11,7	17,9	23,5	29,2	34,8	40,4
	RGSF/B-4+8	12,8	19,2	25,1	31,0	36,9	42,8
	RGSF/B-6+6	12,8	19,2	25,1	31,0	36,9	42,8
	RGSF/B-6+8	13,9	20,6	26,9	33,1	39,4	45,6
	RGSF/B-8+8	15,0	22,1	28,7	35,4	42,0	48,6
STAINLESS STEEL EN 10088-2 I.4404 AISI 316L	RGSF/B-2	6,1	9,1	12,1	15,2	18,2	21,2
	RGSF/B-4	7,2	10,6	13,9	17,3	20,7	24,0
	RGSF/B-6	8,2	11,8	15,4	19,0	22,7	26,3
	RGSF/B-8	9,2	13,1	16,9	20,8	24,6	28,5
	RGSF/B-2+2	8,6	14,3	19,5	24,7	29,8	35,0
	RGSF/B-2+4	9,7	15,7	21,0	26,4	31,7	37,0
	RGSF/B-2+6	10,9	16,9	22,4	27,9	33,4	38,9
	RGSF/B-2+8	12,0	18,4	24,2	29,9	35,7	41,4
	RGSF/B-4+4	10,9	16,9	22,4	27,9	33,4	38,9
	RGSF/B-4+6	12,0	18,4	24,2	29,9	35,7	41,4
	RGSF/B-4+8	13,1	19,7	25,8	31,8	37,9	43,9
	RGSF/B-6+6	13,1	19,7	25,8	31,8	37,9	43,9
RGSF/B-6+8	14,3	21,1	27,5	33,9	40,3	46,7	
RGSF/B-8+8	15,4	22,7	29,5	36,3	43,0	49,8	
ALUMINIUM EN 755-2 EN AWW-6082	RGSF/B-2	2,1	3,1	4,1	5,2	6,2	7,3
	RGSF/B-4	2,5	3,6	4,8	5,9	7,1	8,2
	RGSF/B-6	2,8	4,0	5,3	6,5	7,7	9,0
	RGSF/B-8	3,2	4,5	5,8	7,1	8,4	9,7
	RGSF/B-2+2	2,9	4,9	6,7	8,4	10,2	11,9
	RGSF/B-2+4	3,3	5,4	7,2	9,1	10,9	12,7
	RGSF/B-2+6	3,7	5,8	7,7	9,6	11,4	13,3
	RGSF/B-2+8	4,1	6,3	8,3	10,2	12,2	14,1
	RGSF/B-4+4	3,7	5,8	7,7	9,6	11,4	13,3
	RGSF/B-4+6	4,1	6,3	8,3	10,2	12,2	14,1
	RGSF/B-4+8	4,5	6,7	8,8	10,9	12,9	15,0
	RGSF/B-6+6	4,5	6,7	8,8	10,9	12,9	15,0
	RGSF/B-6+8	4,9	7,2	9,4	11,6	13,7	15,9
	RGSF/B-8+8	5,3	7,7	10,0	12,4	14,7	17,0

RGSC

RGSC is a frame with rounded corners, which reduces the risk of cracks forming in decks and bulkheads that are subjected to heavy loading. Similar to the RGS frame, it is available in sizes 2, 4, 6 and 8. RGSC can also be supplied as multiple frames. Available in mild steel, stainless steel and aluminium. Special cornerblocks and STG-endpackings with rounded corners are available.



		Size in mm							
		W (width)/Multiple Frames							
		x 1	x 2	x 3	x 4	x 5	x 6	x n	
RGSC-2	121	140,5	271	401,5	532	662,5	793	W = 10 +	
RGSC-4	179,5	- " -	- " -	- " -	- " -	- " -	- " -	130,5 x n	
RGSC-6	238	- " -	- " -	- " -	- " -	- " -	- " -		
RGSC-8	296,5	- " -	- " -	- " -	- " -	- " -	- " -		
RGSC-2+2	242		- " -	- " -	- " -	- " -	- " -		
RGSC-2+4	300,5		- " -	- " -	- " -	- " -	- " -		
RGSC-2+6	359		- " -	- " -	- " -	- " -	- " -		
RGSC-2+8	417,5		- " -	- " -	- " -	- " -	- " -		
RGSC-4+4	359		- " -	- " -	- " -	- " -	- " -		
RGSC-4+6	417,5		- " -	- " -	- " -	- " -	- " -		
RGSC-4+8	476		- " -	- " -	- " -	- " -	- " -		
RGSC-6+6	476		- " -	- " -	- " -	- " -	- " -		
RGSC-6+8	534,5		- " -	- " -	- " -	- " -	- " -		
RGSC-8+8	593		- " -	- " -	- " -	- " -	- " -		
RGSC-2+2	232	140,5	n = number of frames wide. Tolerance single frame: Height ± 1 mm, Width ± 0,8 mm. Material thickness is 10 mm. All measurements are in millimeters.						
RGSC-2+4	290,5	- " -							
RGSC-2+6	349	- " -							
RGSC-2+8	407,5	- " -							
RGSC-4+4	349	- " -							
RGSC-4+6	407,5	- " -							
RGSC-4+8	466	- " -							
RGSC-6+6	466	- " -							
RGSC-6+8	524,5	- " -							
RGSC-8+8	583	- " -							



Cornerblocks

Endpacking, left (multiple frames)

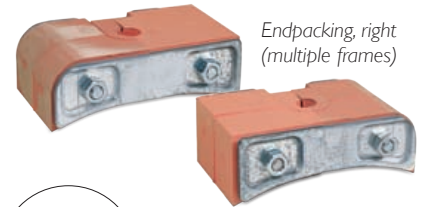

Endpacking, right (multiple frames)

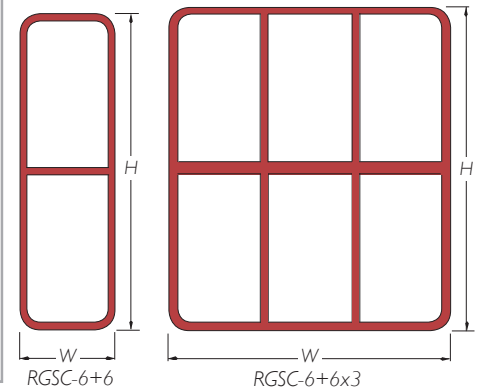
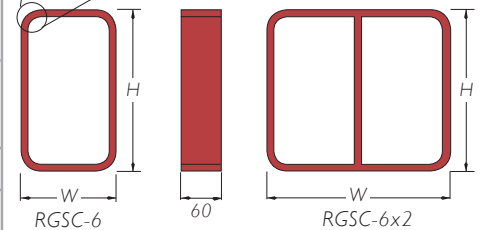
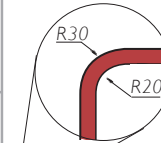

RGSC

WEIGHT CHART

Standard frames come in four sizes: 2, 4, 6 and 8. They are all the same width. Height differences are shown below. The material is 10 mm thick.

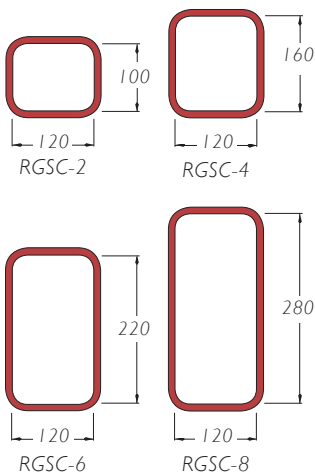

Weight chart in kilograms

Weight in kilograms

MATERIAL	FRAME SIZE	W (width)/Multiple Frames					
		x 1	x 2	x 3	x 4	x 6	
MILD STEEL EN10025-2 S355JR 1.0045 A36	RGSC-2	2,2	3,9	5,7	7,4	9,2	10,9
	RGSC-4	2,7	4,6	6,5	8,4	10,3	12,2
	RGSC-6	3,2	5,4	7,6	9,8	12,0	14,2
	RGSC-8	3,8	6,3	8,9	11,4	14,0	16,5
	RGSC-2+2	3,6	8,1	11,9	15,7	19,5	23,3
	RGSC-2+4	4,2	8,8	12,8	16,7	20,7	24,6
	RGSC-2+6	4,8	9,5	13,6	17,8	21,9	26,0
	RGSC-2+8	5,5	10,3	14,7	19,1	23,5	27,9
	RGSC-4+4	4,8	9,5	13,6	17,8	21,9	26,0
	RGSC-4+6	5,5	10,3	14,7	19,1	23,5	27,9
	RGSC-4+8	5,9	11,1	15,8	20,5	25,1	29,8
	RGSC-6+6	5,9	11,1	15,8	20,5	25,1	29,8
	RGSC-6+8	6,5	12,0	17,0	22,1	27,1	32,1
	RGSC-8+8	7,2	12,9	18,3	23,7	29,1	34,5
STAINLESS STEEL EN 10088-2 1.4404 AISI 316L	RGSC-2	2,2	4,0	5,8	7,6	9,4	11,2
	RGSC-4	2,8	4,7	6,7	8,6	10,6	12,6
	RGSC-6	3,3	5,5	7,8	10,0	12,3	14,5
	RGSC-8	3,9	6,5	9,1	11,7	14,3	16,9
	RGSC-2+2	3,7	8,3	12,2	16,1	20,0	23,9
	RGSC-2+4	4,3	9,0	13,1	17,1	21,2	25,2
	RGSC-2+6	4,9	9,7	14,0	18,2	22,5	26,7
	RGSC-2+8	5,6	10,6	15,1	19,6	24,1	28,6
	RGSC-4+4	4,9	9,7	14,0	18,2	22,5	26,7
	RGSC-4+6	5,6	10,6	15,1	19,6	24,1	28,6
	RGSC-4+8	6,0	11,4	16,2	21,0	25,8	30,6
	RGSC-6+6	6,0	11,4	16,2	21,0	25,8	30,6
	RGSC-6+8	6,7	12,3	17,5	22,6	27,8	32,9
	RGSC-8+8	7,4	13,2	18,8	24,3	29,9	35,4
ALUMINIUM EN 755-2 EN AW-6082	RGSC-2	0,8	1,4	2,0	2,6	3,2	3,8
	RGSC-4	1,0	1,6	2,3	3,0	3,6	4,3
	RGSC-6	1,1	1,9	2,7	3,4	4,2	5,0
	RGSC-8	1,3	2,2	3,1	4,0	4,9	5,8
	RGSC-2+2	1,3	2,8	4,2	5,5	6,9	8,2
	RGSC-2+4	1,5	3,1	4,5	5,9	7,2	8,6
	RGSC-2+6	1,7	3,3	4,8	6,2	7,7	9,1
	RGSC-2+8	1,9	3,6	5,2	6,7	8,3	9,8
	RGSC-4+4	1,7	3,3	4,8	6,2	7,7	9,1
	RGSC-4+6	1,9	3,6	5,2	6,7	8,3	9,8
	RGSC-4+8	2,1	3,9	5,5	7,2	8,8	10,4
	RGSC-6+6	2,1	3,9	5,5	7,2	8,8	10,4
	RGSC-6+8	2,3	4,2	6,0	7,7	9,5	11,2
	RGSC-8+8	2,5	4,5	6,4	8,3	10,2	12,1

RGSK/RGSbtb

RGSK is an extended, standard RGS frame, with machined grooves for stayplates and compression plates. The material is 10 mm thick on the ends and 12 mm thick on the sides. RGSK is available in the four standard sizes: 2, 4, 6 and 8.

RGSK frames are recommended if pooling of water on the transit face makes it necessary to install packing blocks at a certain distance from the deck or bulkhead.

The frame is 120 mm deep (as opposed to 60 mm on a RGS) and of standard internal width (120 mm).

It may be used in multiple frames, see page 17.

RGSbtb is a double frame which is packed from both sides, enabling a pressure seal of up to 5 bar (test pressure) on either side of the penetration. Installations with this frame can be pressure tested from the space between the pack block units. They also conform to jet-fire rating.

An RGSbtb frame can be used to protect cables from water penetration, combined with EMC protection. One side of the packing takes care of water penetration and the other side gives EMC protection.

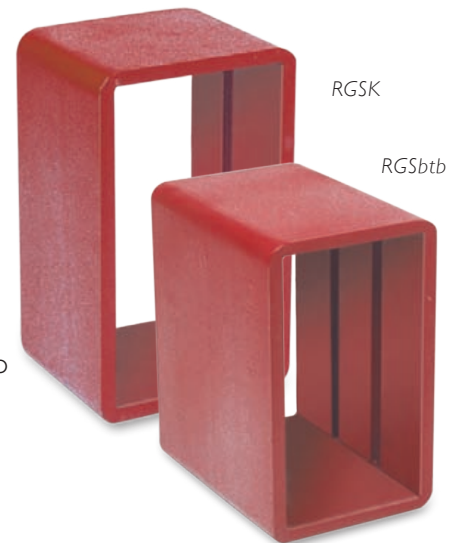

The frame is 10 mm thick on the ends and 12 mm thick on the sides. It is 200 mm deep. Other dimensions are the same as for the standard RGS.

RGSbtb is available in the four standard sizes: 2, 4, 6, and 8. They may be used in multiple frames.

Size in mm							
FRAME SIZE	H (height)	W (width)/Multiple Frames					
		x 1	x 2	x 3	x 4	x 5	x n
RGSK/RGSbtb-2	121	144,5	275	405,5	536	666,5	W = 14 +
RGSK/RGSbtb-4	179,5	- " -	- " -	- " -	- " -	- " -	130,5 x n
RGSK/RGSbtb-6	238	- " -	- " -	- " -	- " -	- " -	
RGSK/RGSbtb-8	296,5	- " -	- " -	- " -	- " -	- " -	
RGSK/RGSbtb-2+2	232		- " -	- " -	- " -	- " -	
RGSK/RGSbtb-2+4	290,5		- " -	- " -	- " -	- " -	
RGSK/RGSbtb-2+6	349		- " -	- " -	- " -	- " -	
RGSK/RGSbtb-2+8	407,5		- " -	- " -	- " -	- " -	
RGSK/RGSbtb-4+4	349		- " -	- " -	- " -	- " -	
RGSK/RGSbtb-4+6	407,5		- " -	- " -	- " -	- " -	
RGSK/RGSbtb-4+8	466		- " -	- " -	- " -	- " -	
RGSK/RGSbtb-6+6	466		- " -	- " -	- " -	- " -	
RGSK/RGSbtb-6+8	524,5		- " -	- " -	- " -	- " -	
RGSK/RGSbtb-8+8	583		- " -	- " -	- " -	- " -	

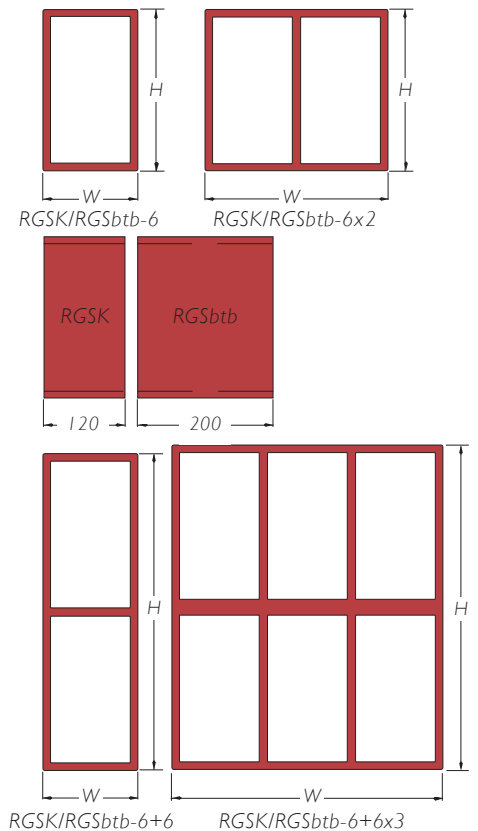

Tolerance single frame:
Height ± 1 mm, Width ± 0.8 mm.
Material thickness is 10 mm.

RGSK

WEIGHT CHART

Standard frames come in four sizes: 2, 4, 6 and 8. They are all the same width. Height differences are shown below.

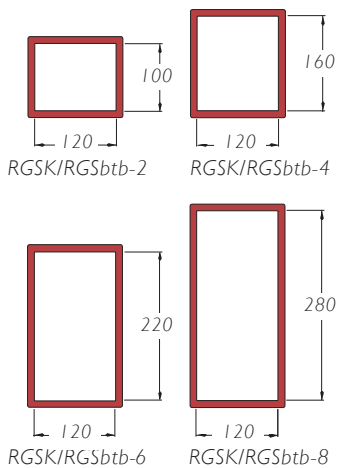

Weight chart in kilograms

Weight in kilograms

MATERIAL	FRAME SIZE	W (width)/Multiple Frames					
		x 1	x 2	x 3	x 4	x 5	x 6
MILD STEEL EN 10025-2 S355JR 1.0045 A36	RGSK-2	4,7	7,7	10,7	13,7	16,7	19,7
	RGSK-4	6,0	9,3	12,6	15,9	19,2	22,5
	RGSK-6	7,3	10,9	14,5	18,2	21,8	25,4
	RGSK-8	8,7	12,5	16,4	20,4	24,3	28,2
	RGSK-2+2	7,8	11,9	16,1	20,4	24,6	28,8
	RGSK-2+4	9,2	13,6	18,1	22,6	27,1	31,6
	RGSK-2+6	10,6	15,2	20,0	24,8	29,5	34,3
	RGSK-2+8	11,9	16,9	22,0	27,0	32,1	37,1
	RGSK-4+4	10,6	15,2	20,0	24,8	29,5	34,3
	RGSK-4+6	11,9	16,9	22,0	27,0	32,1	37,1
	RGSK-4+8	13,2	18,4	23,7	29,1	34,4	39,7
	RGSK-6+6	13,2	18,4	23,7	29,1	34,4	39,7
	RGSK-6+8	14,5	20,0	25,5	31,0	36,5	42,5
	RGSK-8+8	15,9	21,6	27,4	33,2	38,9	45,2
STAINLESS STEEL EN 10088-2 1.4404 AISI 316L	RGSK-2	4,8	7,9	11,0	14,1	17,1	20,2
	RGSK-4	6,2	9,5	12,9	16,3	19,7	23,1
	RGSK-6	7,5	11,2	14,9	18,6	22,3	26,0
	RGSK-8	8,9	12,8	16,8	20,9	24,9	28,9
	RGSK-2+2	8,0	12,2	16,5	20,9	25,2	29,5
	RGSK-2+4	9,4	13,9	18,5	23,2	27,8	32,4
	RGSK-2+6	10,9	15,6	20,5	25,4	30,3	35,2
	RGSK-2+8	12,2	17,3	22,5	27,7	32,8	38,0
	RGSK-4+4	10,9	15,6	20,5	25,4	30,3	35,2
	RGSK-4+6	12,2	17,3	22,5	27,7	32,8	38,0
	RGSK-4+8	13,5	18,9	24,4	29,8	35,3	40,7
	RGSK-6+6	13,5	18,9	24,4	29,8	35,3	40,7
	RGSK-6+8	14,9	20,5	26,3	32,1	37,8	43,6
	RGSK-8+8	16,3	22,1	28,2	34,2	40,3	46,3
ALUMINIUM EN 755-2 EN AW-6082	RGSK-2	1,7	2,7	3,7	4,8	5,8	6,8
	RGSK-4	2,1	3,3	4,5	5,6	6,8	7,9
	RGSK-6	2,6	3,8	5,1	6,4	7,6	8,9
	RGSK-8	3,1	4,4	5,8	7,2	8,5	9,9
	RGSK-2+2	2,7	4,2	5,7	7,2	8,6	10,1
	RGSK-2+4	3,2	4,8	6,4	8,0	9,5	11,1
	RGSK-2+6	3,7	5,3	7,0	8,7	10,3	12,0
	RGSK-2+8	4,2	5,9	7,7	9,5	11,2	13,0
	RGSK-4+4	3,7	5,3	7,0	8,7	10,3	12,0
	RGSK-4+6	4,2	5,9	7,7	9,5	11,2	13,0
	RGSK-4+8	4,6	6,4	8,3	10,2	12,0	13,9
	RGSK-6+6	4,6	6,4	8,3	10,2	12,0	13,9
	RGSK-6+8	5,1	7,0	9,0	11,0	12,9	14,9
	RGSK-8+8	5,6	7,6	9,7	11,7	13,8	15,8

RGSbtb

WEIGHT CHART

Standard frames come in four sizes: 2, 4, 6 and 8. They are all the same width. Height differences are shown below.

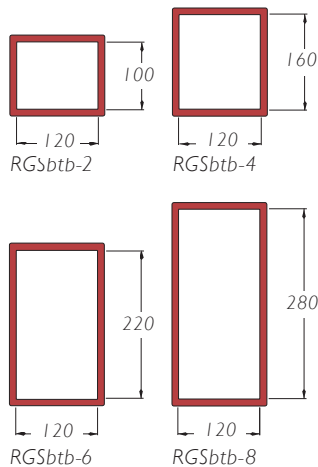

Weight in kilograms							
MATERIAL	FRAME SIZE	W (width)/Multiple Frames					
		x 1	x 2	x 3	x 4	x 5	x 6
MILD STEEL EN10025-2 S355JR 1,0045 A36	RGSbtb-2	7,9	13,0	18,4	23,7	29,1	34,4
	RGSbtb-4	10,1	15,8	21,7	27,6	33,5	39,4
	RGSbtb-6	12,4	18,6	25,1	31,5	38,0	44,4
	RGSbtb-8	14,5	21,2	28,2	35,2	42,2	49,2
	RGSbtb-2+2	13,5	20,9	28,5	36,1	43,7	51,3
	RGSbtb-2+4	15,3	23,3	31,5	39,7	47,8	56,0
	RGSbtb-2+6	17,8	26,3	35,0	43,7	52,4	61,1
	RGSbtb-2+8	20,0	29,1	38,4	47,7	56,9	66,2
	RGSbtb-4+4	17,8	26,3	35,0	43,7	52,4	61,1
	RGSbtb-4+6	20,0	29,1	38,4	47,7	56,9	66,2
	RGSbtb-4+8	22,3	31,9	41,7	51,5	61,3	71,1
	RGSbtb-6+6	22,3	31,9	41,7	51,5	61,3	71,1
	RGSbtb-6+8	24,5	34,7	45,1	55,5	65,8	76,2
	RGSbtb-8+8	26,6	37,3	48,2	59,2	70,1	81,0
STAINLESS STEEL EN 10088-2 1.4404 AISI 316L	RGSbtb-2	8,1	13,3	18,8	24,3	29,8	35,3
	RGSbtb-4	10,4	16,2	22,3	28,3	34,4	40,4
	RGSbtb-6	12,7	19,1	25,7	32,3	38,9	45,5
	RGSbtb-8	14,9	21,7	28,9	36,1	43,2	50,4
	RGSbtb-2+2	13,8	21,4	29,2	37,0	44,8	52,6
	RGSbtb-2+4	15,7	23,9	32,3	40,7	49,0	57,4
	RGSbtb-2+6	18,3	27,0	35,9	44,8	53,7	62,6
	RGSbtb-2+8	20,5	29,8	39,3	48,9	58,4	67,9
	RGSbtb-4+4	18,3	27,0	35,9	44,8	53,7	62,6
	RGSbtb-4+6	20,5	29,8	39,3	48,9	58,4	67,9
	RGSbtb-4+8	22,9	32,7	42,8	52,8	62,9	72,9
	RGSbtb-6+6	22,9	32,7	42,8	52,8	62,9	72,9
	RGSbtb-6+8	25,1	35,6	46,1	56,9	67,5	78,1
	RGSbtb-8+8	27,3	38,2	49,4	60,6	71,8	83,0
ALUMINIUM EN 755-2 EN AW-6082	RGSbtb-2	2,8	4,6	6,5	8,3	10,2	12,0
	RGSbtb-4	3,5	5,5	7,6	9,7	11,7	13,8
	RGSbtb-6	4,3	6,5	8,8	11,0	13,3	15,5
	RGSbtb-8	5,1	7,4	9,9	12,3	14,8	17,2
	RGSbtb-2+2	4,7	7,3	10,0	12,7	15,3	18,0
	RGSbtb-2+4	5,4	8,2	11,1	13,9	16,8	19,6
	RGSbtb-2+6	6,2	9,2	12,3	15,3	18,4	21,4
	RGSbtb-2+8	7,0	10,2	13,5	16,7	20,0	23,2
	RGSbtb-4+4	6,2	9,2	12,3	15,3	18,4	21,4
	RGSbtb-4+6	7,0	10,2	13,5	16,7	20,0	23,2
	RGSbtb-4+8	7,8	11,2	14,6	18,1	21,5	24,9
	RGSbtb-6+6	7,8	11,2	14,6	18,1	21,5	24,9
	RGSbtb-6+8	8,6	12,2	15,8	19,5	23,1	26,7
	RGSbtb-8+8	9,3	13,1	16,9	20,8	24,6	28,4

RGSR

RGSR is used in decks and bulkheads which are subjected to high degrees of stress. The additional, rounded ends prevent stress cracking. The radius of the ends is 70 mm on otherwise standard 2, 4, 6 and 8 model RGS frames.

RGSR can be used in multiple frames.

For weight charts and installation details, singularly or in multiple frames, contact MCT Brattberg.



Multiple Frames



HORIZONTAL MULTIPLE FRAMES

Horizontal multiple frames are described by listing the frame type and size x the desired number of horizontal openings.

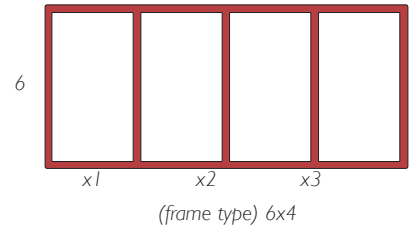

Designation:

VERTICAL MULTIPLE FRAMES

Vertical multiple frames are described by listing the bottom frame type and size + the next frame type and size.

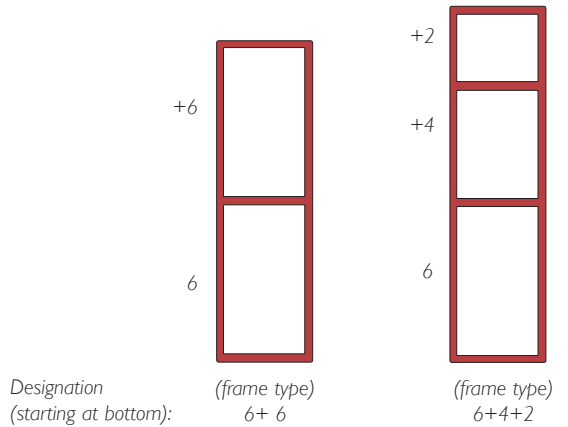

Designation (starting at bottom):

VERTICAL AND HORIZONTAL MULTIPLE FRAMES

List the entire vertical frames x the desired number of horizontal repetitions.

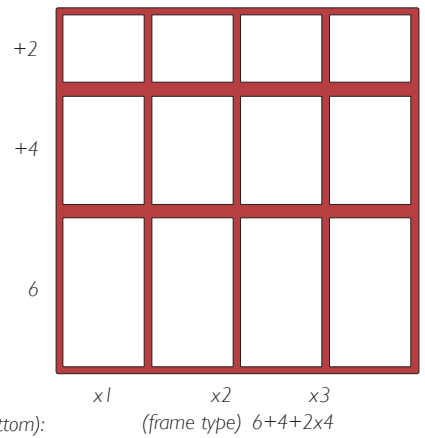

Designation (starting at bottom):

NOTE: All multiple frame designations must be preceded by the frame type.

RGP-round holes

RGP is a Lycron frame for assembly in round holes or tubes. It is available in seven sizes (see table) and is packed with standard MCT insert blocks. The metal parts are galvanized or stainless steel.

RGPO is a Lycron frame with open sides intended for installation in holes where cables have already been installed. This is also available in seven sizes.

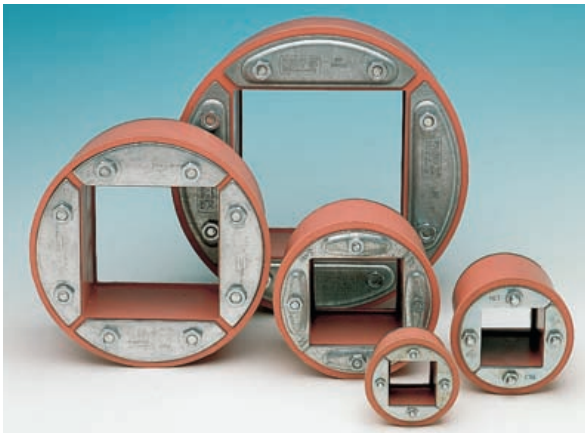

RGP is a circular seal for holes or pipes.



RGPO is an open-sided RGP frame.

Dimensions in mm		
FRAME SIZE	PACKING AREA	DEPTH AND DIAMETER
RGP 50/L60		
RGP 50/L30		
RGP 70		
RGP 100		
RGP 125		
RGP 150		
RGP 200		

Weight in kilograms						
RGP 50/L60	RGP 50/L30	RGP 70	RGPI00	RGPI25	RGPI50	RGPI200
0.25	0.11	0.4	0.7	1.0	1.8	3.0

Sleeves for RGP Frames

The sleeves are available in seven sizes, for welding, casting or bolting to the structure.

The standard materials are mild steel, stainless steel and aluminium.



TYPE S WITHOUT FLANGE

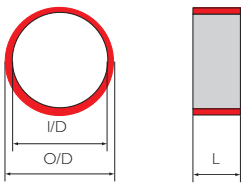

TYPE SFR WITH ROUND FLANGE

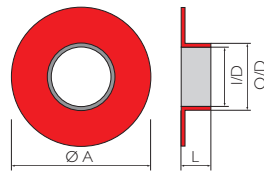

TYPE SFRB WITH ROUND FLANGE AND PRE DRILLED HOLES

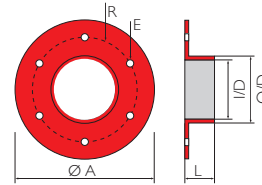

TYPE SFRBO (OPENABLE) WITH ROUND FLANGE AND PRE DRILLED HOLES

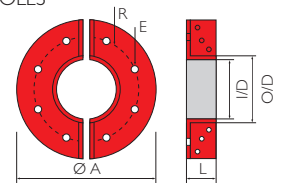

Type S without flange				
Type/size	O/D mm	I/D mm	L mm	Weight kg
S 50/L30	63	51 ¹⁾	35	0.3
S 50/L60	63	51 ¹⁾	70	0.6
S 70	83	71 ¹⁾	70	0.8
S 100	114	102 ¹⁾	70	1.1
S 125	140	127 ¹⁾	70	1,4
S 150	164	152 ¹⁾	82	1.9
S 200	214	202 ¹⁾	82	2.5

Type SFR with round flange						
Type/size	O/D mm	I/D mm	L mm	A mm	Weight kg	
SFR 50/L60	63	51 ¹⁾	73	145	1.2	
SFR 70	83	71 ¹⁾	74	185	2.1	
SFR 100	114	102 ¹⁾	74	215	2.7	
SFR 125	140	127 ¹⁾	74	240	4.0	
SFR 150	164	152 ¹⁾	86	264	4.0	
SFR 200	214	202 ¹⁾	86	315	5.1	

¹⁾ 0-0.3 mm

¹⁾ 0-0.3 mm

Type SFRB and SFRBO (open) with round flange								
Type/size	O/D mm	I/D mm	L mm	A mm	R mm	E mm	Qty of holes	Weight kg
SFRB (O) 50/L60	63	51 ¹⁾	73	145	52.5	9	4	1.2
SFRB (O) 70	83	71 ¹⁾	74	185	68.0	9	4	2.1
SFRB (O) 100	114	102 ¹⁾	74	215	82.0	9	4	2.7
SFRB (O) 125	140	127 ¹⁾	74	240		9	4	4.0
SFRB (O) 150	164	152 ¹⁾	86	264	108.0	11	6	4.0
SFRB (O) 200	214	202 ¹⁾	86	315	132.0	11	6	5.1

¹⁾ 0-0.3 mm

Components

STAYPLATE

To be placed between each row of blocks. Stayplates simplify installation, increase stability and anchor blocks within the frame. Plates come in galvanized or stainless steel, and aluminium.



STG-ENDPACKING

Installed between compression plate and the top of the frame, completing the seal. Made of Lycron with galvanized or stainless steel fittings.



COMPRESSION PLATE

Usually assembled above top row of blocks. The plate bolt is tightened to compress blocks around cables, while providing room for STG endpacking. Comes in GRP, glassfibre reinforced polyester.

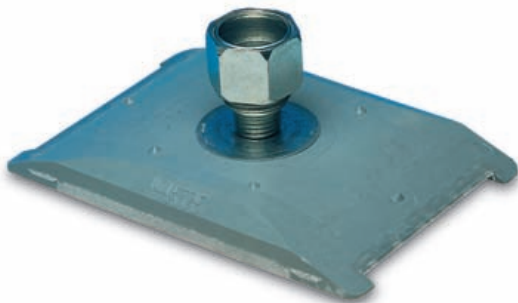

PTG-PRESSWEDGE

Can be used as an alternative to compression plate and STG. Can also be placed anywhere in the frame. Made of Lycron, with galvanized or stainless steel fittings. Must always be installed in combination with a stayplate.

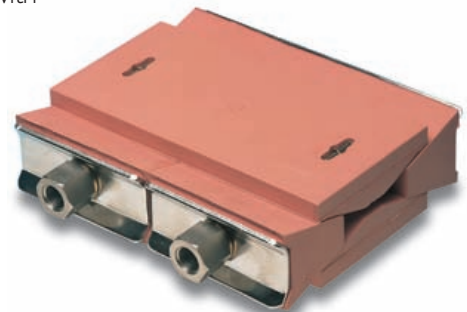

Weight in kilograms			
STG	PTG	COMPRESSION PLATE	STAYPLATE
0,6	0,82	0,24	0,13

Accessories

LUBRICANT

For pressure-tight Installations.



BLOCK SELECTOR

For cable/pipe measurement.

STD insert



AddBlock



FLEX HEAD SPANNER

For end packer & RGP installation.



CABLE SEPARATOR

Support cables during installation.



PACKING TOOL

Compresses insert block to hold cable/pipes during partial installations.



END PACKER PULLER

For re-entry into system.

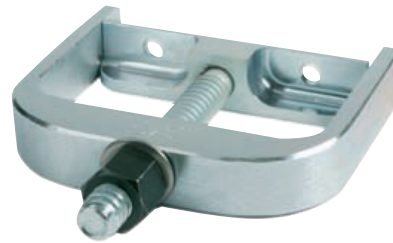

QUICK RELEASE SPANNER

For Compression Plate Installation.



BLANKING PLATE

Seals frame prior to block installation.



Planning the Packing Space

The space in a frame, which can be used exclusively for holding insert blocks, is called the packing space. In the RGS-type frames the compression system always occupy 40 mm of each frame.

In the RGP frames no compression system or stayplates are necessary. Therefore the packing space consists of the entire interior area of the frame.

Tables to help you determine which insert block to use are on pages 27 (the Standard system) and 28 (AddBlocks).

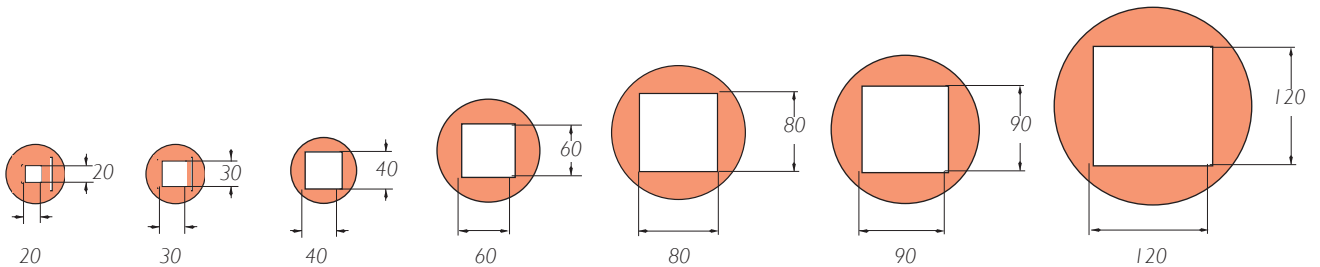
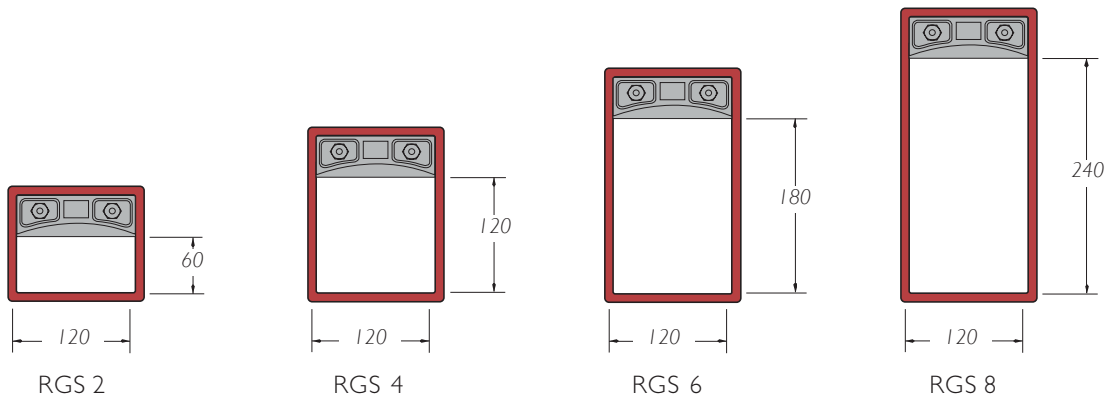

RGP 50/L60 RGP 50/L30 RGP 70 RGP 100 RGP 125 RGP 150 RGP 200

RGS maximum number of cables and pipes							
Frame sizes	Block sizes						
	15	20	30	40	60	90	120
RGS 2	32	18	8	3	2	-	-
RGS 4	64	36	16	9	4	1	1
RGS 6	96	54	24	12	6	2	1
RGS 8	128	72	32	18	8	2	2

RGP maximum number of cables and pipes							
Frame sizes	Block sizes						
	15	20	30	40	60	90	120
RGP 50/L30	4	1	1	-	-	-	-
RGP 50/L60	1	1	-	-	-	-	-
RGP 70	4	4	1	1	-	-	-
RGP 100	16	9	4	1	1	-	-
RGP 125	25	16	4	1	1	-	-
RGP 150	36	16	9	4	1	1	-
RGP 200	64	36	16	9	4	1	1

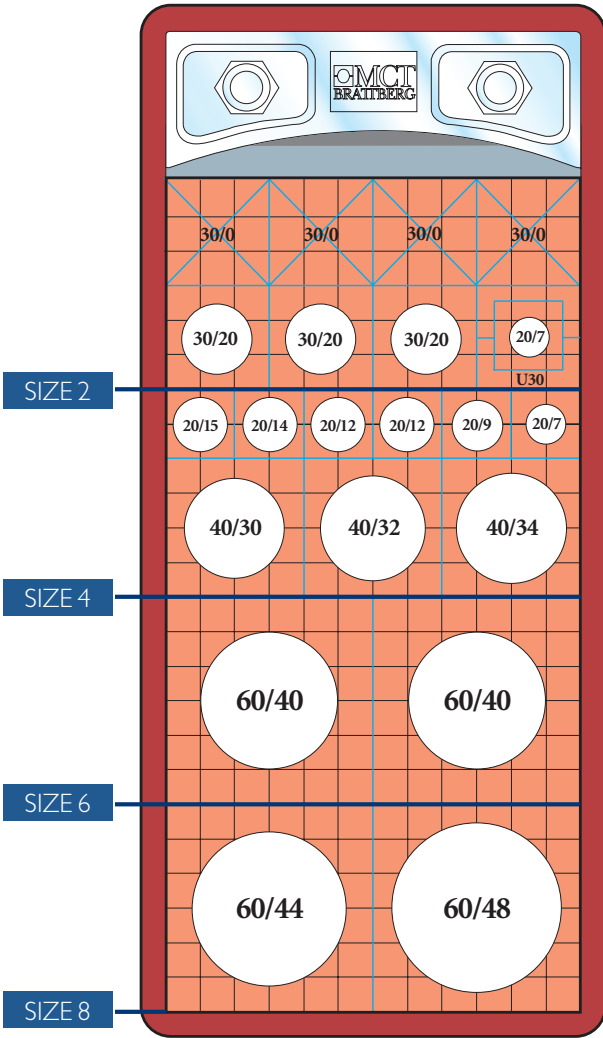

A couple of examples of pack plans (RG Plan) are shown here. RGS to the left and RGP below. The largest cables are placed at the bottom.

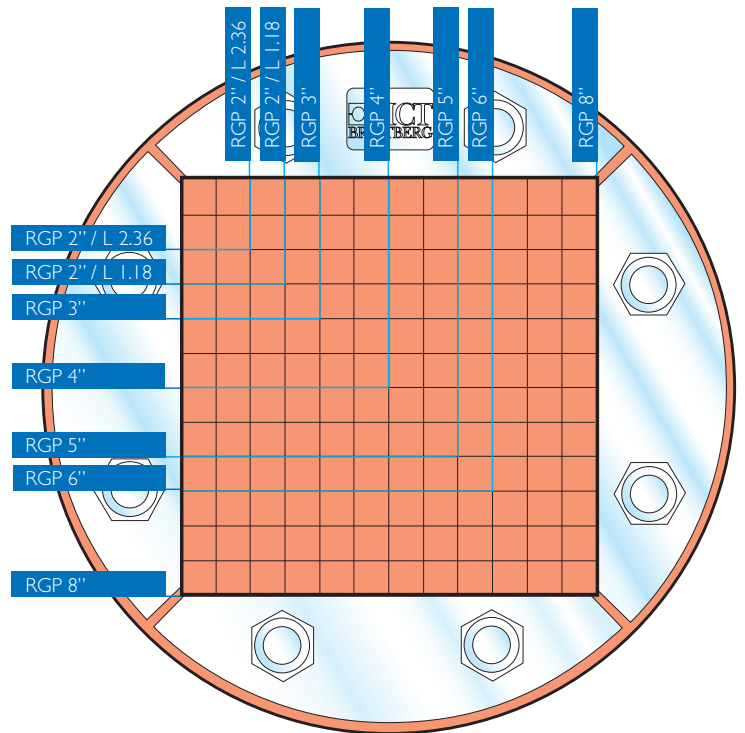

Combination frame width compared with width of cable size						
Cabletype	Frame-size	Cable size width in mm				
		150	200	300	400	600
Signal		6	6 × 2	6 × 3	6 × 4	6 × 5
Power		4	4 × 2	4 × 3	4 × 4	4 × 5
Comb.		6	6 × 2	6 × 3	6 × 4	6 × 5

Packing Plan

RGS, RGSF, RGSK, RGSR and RGSbtb

Packing Plan

RGS, RGSF, RGSK, RGSR, RGSbtb and RGP

The correct frame size can be determined by using this plan.

The notes to the right side of the plan represent the available packing space for frame size 2, 4, 6 and 8.

It is not necessary to show stay plates, compression plates or endpackings since sufficient space for these is already reserved in the tables.

The notes to the left side of the plan represent the available packing space for the different RGP frames.

Dimensions of Standard insert blocks, Add-blocks, Plugs and U-blocks, see pages 26-30.

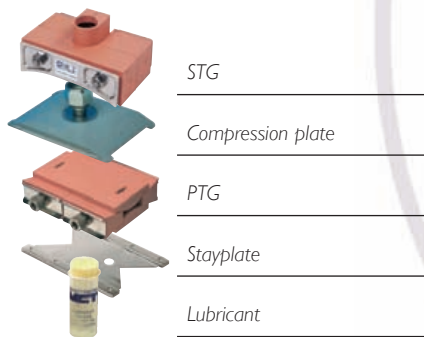

Blocks

RGP 50/L60

RGP 50/L30

RGP 70

RGP 100

RGP 125

RGP 150

RGP 200

10x10 mm

SIZE 2

SIZE 4

SIZE 6

SIZE 8

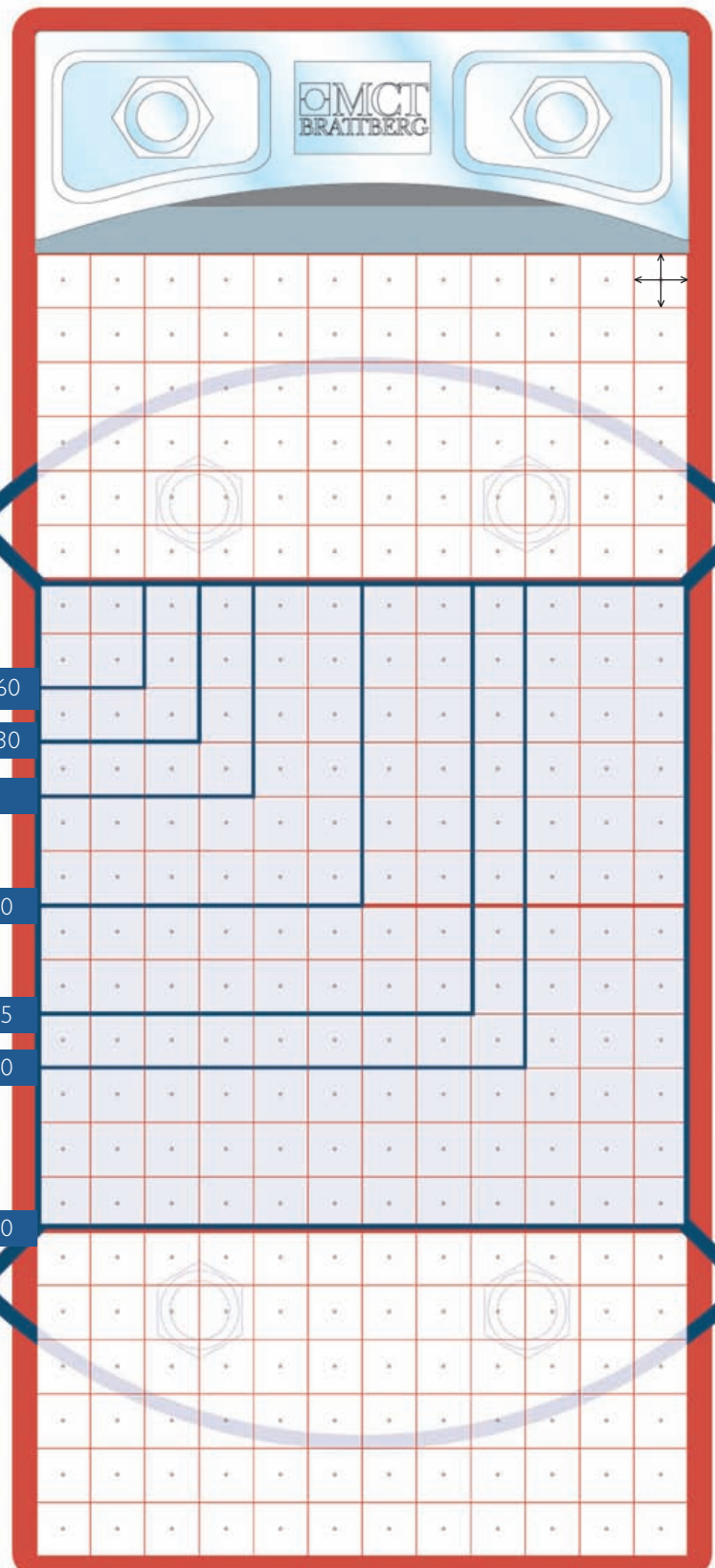

Design Manager Software

MCT Brattberg - WinRG Plan Transit

Configure cable/pipe penetrations quickly and easily with MCT Brattberg Cable Transit Planning Software. Simply input the transit requirements and software automatically configures the seal, along with all necessary components, blank blocks, stayplates and compression systems -at the touch of a button. Faster and simpler than time-consuming manual methods, it's the perfect solution for busy engineers/designers.

The software includes a wealth of project-specific information ready to use in your designs:

- Frame/item name/location
- Cable name(s) with type and diameter
- Block type
- Compression type
- Expansion capacity

Select from the available options to adapt on existing project, or to create an entirely new design.

The indispensable software is available from MCT Brattberg free of charge. Registered users can also receive regular product upgrades to ensure that your designs are always up to date.

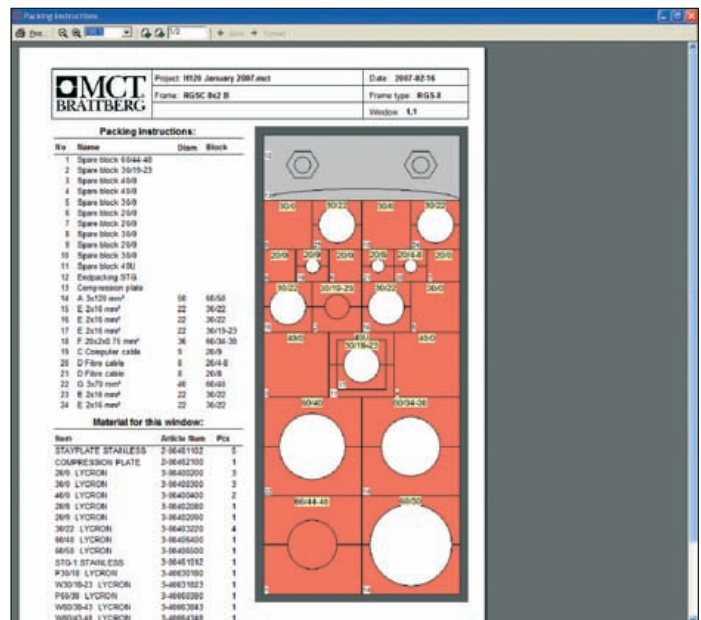
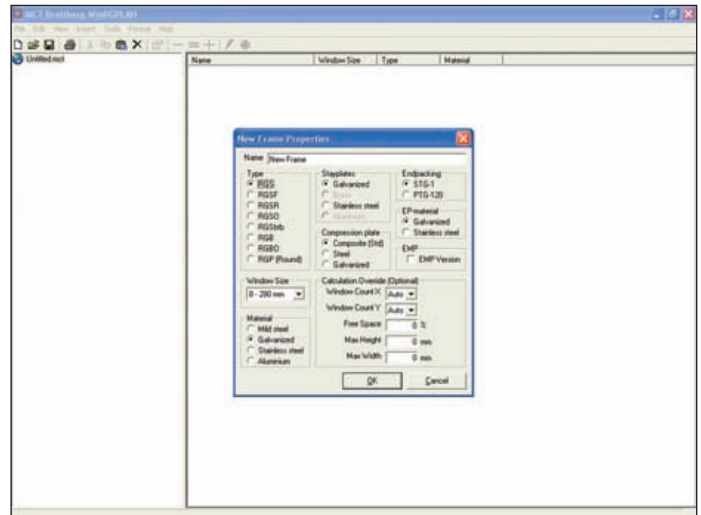

Standard Insert Blocks

Our range of blocks accomodates cables between 4 and 100 mm in diameter. It is important that the insert block is the right size, with respect to the cable, to ensure a proper seal.

Measure the cable diameters carefully and choose insert blocks accordingly. With the sizing chart on next page you can choose the correct size of insert blocks.

Blocks are referred to by their width (A) and hole diameter (B). Thus a block with a width of 15 mm and a hole diameter of 4 mm is referred to as 15/4. This designation is moulded into the block.

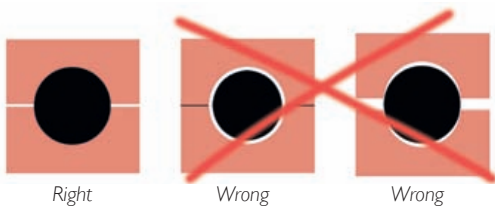
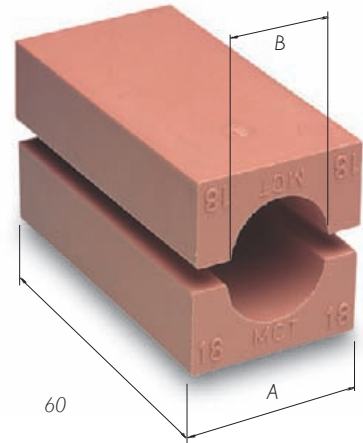

Spare Blocks

Surplus room in each frame is filled out with solid insert blocks. Called spares, they bear the designation A/0.

Blocks are referred to by their width (A), followed by the designation /0 (indicating solid). Thus a block with a width and height of 15 mm is referred to as 15/0.

The length of insert blocks is always 60 mm.

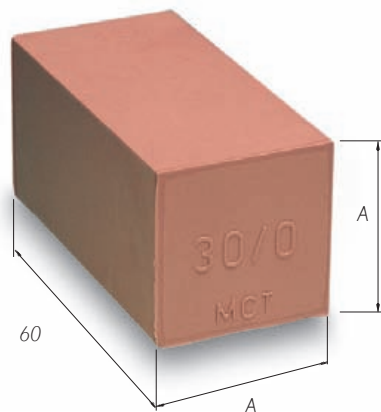

BLOCK SIZE Width (A) = Height (A)	BLOCK DESIGNATION
5 x 5 Only in strips of 24 pcs	24 x 5/0
10 x 10 Only in strips of 12 pcs	12 x 10/0
15 x 15	15/0
20 x 20	20/0
30 x 30	30/0
40 x 40	40/0
60 x 60	60/0

Size in mm

CABLE DIAM.	A				B
	15	20	30	40	
3.5-4.5	15/4	20/4			4
4.5-5.5	15/5	20/5			5
5.5-6.5	15/6	20/6			6
6.5-7.5	15/7	20/7			7
7.5-8.5	15/8	20/8			8
8.5-9.5	15/9	20/9			9
9.5-10.5		20/10			10
10.5-11.5		20/11			11
11.5-12.5		20/12	30/12		12
12.5-13.5		20/13	30/13		13
13.5-14.5		20/14	30/14		14
14.5-15.5		20/15	30/15		15
15.5-16.5		20/16	30/16		16
16.5-17.5			30/17		17
17.5-18.5			30/18		18
18.5-19.5			30/19		19
19.5-20.5			30/20		20
20.5-21.5			30/21		21
21.5-22.5			30/22	40/22	22
22.5-23.5			30/23	40/22	23
23.5-24.5			30/24	40/24	24
24.5-25.5				40/24	24

CABLE DIAM.	A			B
	40	60	90	
25.5-27.5	40/26			26
27.5-29.5	40/28			28
29.5-31.5	40/30			30
31.5-33.5	40/32	60/32		32
33.5-35.5	40/34	60/34		34
35.5-37.5		60/36		36
37.5-39.5		60/38		38
39.5-41.5		60/40		40
41.5-43.5		60/42		42
43.5-45.5		60/44		44
45.5-47.5		60/46		46
47.5-49.5		60/48		48
49.5-51.5		60/50	90/50	50
51.5-53.5		60/52	90/52	52
53.5-55.5		60/54	90/54	54

CABLE DIAM.	A		B
	90	120	
55.5-57.5	90/56		56
57.5-59.5	90/58		58
59.5-61.5	90/60		60
61.5-63.5	90/62		62
63.5-65.5	90/64		64
65.5-67.5	90/66		66
67.5-69.5	90/68		68
69.5-71.5	90/70		70
71.5-73.5		120/72	72
73.5-75.5		120/74	74
75.5-77.5		120/76	76
77.5-79.5		120/78	78
79.5-81.5		120/80	80
81.5-83.5		120/82	82
83.5-85.5		120/84	84
85.5-87.5		120/86	86
87.5-89.5		120/88	88
89.5-91.5		120/90	90
91.5-93.5		120/92	92
93.5-95.5		120/94	94
95.5-97.5		120/96	96
97.5-99.5		120/98	98
99.5-101.5		120/100	100

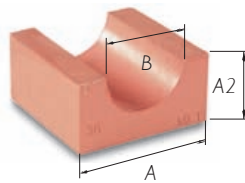

Blocks are referred to by their width(A) and hole diameter (B). Thus a module with a width of 15 mm and a hole diameter of 4 mm is referred to as 15/4.

Weight in grams per half

BLOCK	WEIGHT	BLOCK	WEIGHT	BLOCK	WEIGHT	BLOCK	WEIGHT	BLOCK	WEIGHT
24 x 5/0	58	20/6	17	30/19	28	60/42	104	120/72	494
12 x 10/0	113	20/7	17	30/20	27	60/44	98	120/74	485
15/0	20	20/8	16	30/21	25	60/46	91	120/76	472
20/0	38	20/9	15	30/22	24	60/48	84	120/78	462
30/0	84	20/10	14	30/23	22	60/50	77	120/80	448
40/0	150	20/11	13	30/24	21	60/52	59	120/82	437
60/0	338	20/12	13	40/22	57	60/54	61	120/84	425
		20/13	12	40/24	54	90/50	287	120/86	415
		20/14	11	40/26	50	90/52	279	120/88	403
15/4	10	20/15	10	40/28	47	90/54	273	120/90	385
15/5	10	20/16	9	40/30	42	90/56	262	120/92	368
15/6	10	30/12	36	40/32	37	90/58	255	120/94	360
15/7	10	30/13	36	40/34	32	90/60	243	120/96	351
15/8	9	30/14	35	60/32	131	90/62	239	120/98	332
15/9	8	30/15	34	60/34	127	90/64	229	120/100	313
20/4	18	30/16	33	60/36	122	90/66	220	120/108	243
20/5	18	30/17	31	60/38	116	90/68	211		
		30/18	30	60/40	110	90/70	204		

AddBlock

There are eleven different sizes of AddBlock. By tearing off the wing-like inserts, which are of varying thickness, and inserting them in the main block it is possible to accommodate 66 different cable and pipe dimensions, from 3.5 mm to 69.5 mm. The inserts are fitted with a locating ridge that fits exactly into furrows in the main block. These stop the block from "telescoping".

A seal using AddBlocks is as secure and tight as one using standard blocks. Both types can be combined in a transit, which makes the MCT Brattberg seal system very flexible.

The AddBlock's basic dimension is given at bottom slot center, and that's the maximum cable dimension the block is designed for.

Dimensions are also clearly marked on the four insert sheets. Simply select, tear off and insert.

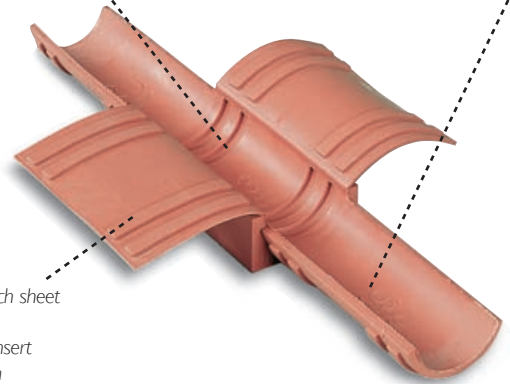

On the bottom of each sheet you'll find four locking devices to keep the insert in place, making each AddBlock thoroughly secure.

Eleven blocks and 66 dimensions

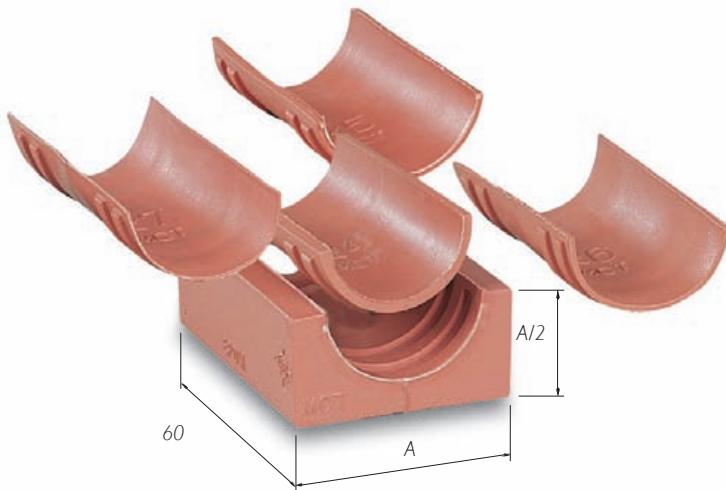

AddBlocks are all the same length as standard blocks, 60 mm. The width of standard blocks (A measurement, see table) are 20, 30, 40, 60 or 90 mm.

ADDBLOCK DIMENSION	CABLE OR PIPE DIMENSION	WEIGHT PER HALF (G)
20/4 - 8	3.5 - 8.5	23
20/9 - 13	8.5 - 13.5	23
30/14 - 18	13.5 - 18.5	45
30/19 - 23	18.5 - 23.5	43
40/24 - 28	23.5 - 28.5	71
40/29 - 33	28.5 - 33.5	62
60/34 - 38	33.5 - 38.5	150
60/39 - 43	38.5 - 43.5	136
60/44 - 48	43.5 - 49.5	128
90/50 - 58	49.5 - 59.5	348
90/60 - 68	59.5 - 69.5	318

Plugs and Wraps

P20/8

Plug, diameter 8 mm. Fits in AddBlock 20/4-8

P20/8

Plug, diameter 8 mm. With wrap-around casing
W-20-8/13 it fits in AddBlock 20/9-13

P30/18

Plug, diameter 18 mm. Fits in AddBlock 30/14-18

P30/18

Plug, diameter 18 mm. With wrap-around casing
W-30-18/23 it fits in AddBlock 30/19-23

P40/28

Plug, diameter 28 mm. Fits in AddBlock 40/24-28

P40/28

Plug, diameter 28 mm. With wrap-around casing
W-40-28/33 it fits in AddBlock 40/29-33

P60/38

Plug, diameter 38 mm. Fits in AddBlock 60/34-38

P60/38

Plug, diameter 38 mm. With wrap-around casing
W-60-38/43 it fits in AddBlock 60/39-43

With additional casing

W-60-43/48 it fits AddBlock 60/44-48

The plug's main purpose is to prepare coming installations by creating a spare block together with an AddBlock.



Plug

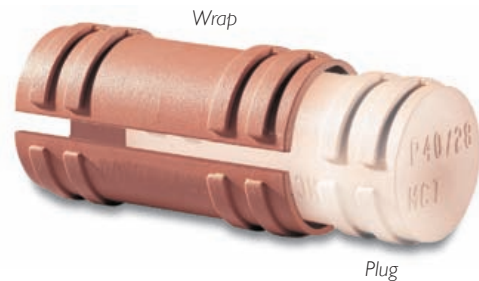

Wrap

Plug

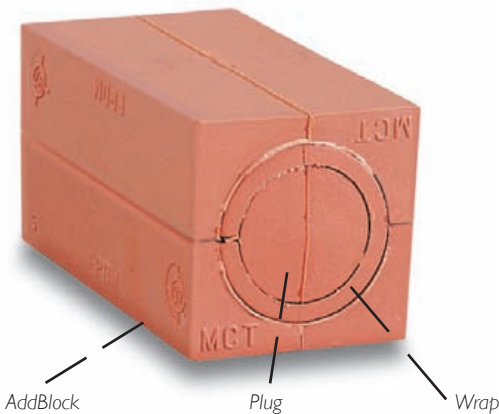

In the table you see which plug, or combination of plug and wrap-around casing, to use when turning an AddBlock into a spare block.

ADDBLOCK	PLUG	WRAP
20/4 - 8	P 20/8	
20/9 - 13	P 20/8 +	W 20/8-13
30/14 - 18	P 30/18	
30/19 - 23	P 30/18 +	W 30/18-23
40/24 - 28	P 40-28	
40/29 - 33	P 40-28 +	W 40/28-33
60/34 - 38	P 60/38	
60/39 - 43	P 60/38 +	W 60/38-43
60/44 - 48	P 60/38 +	W 60/38-43 and W 60/43-48

U-Blocks

The U-Block is used to convert the external dimensions of Insert Blocks, AddBlocks and Spare Blocks to the next modular size.

For example a 30/15 Insert Block can be enlarged by placing it into a U40, giving the new size of 40/15.

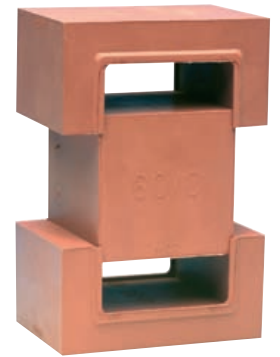
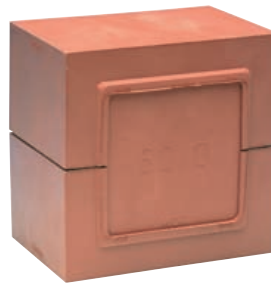
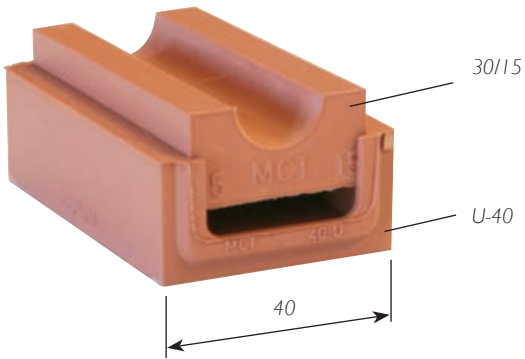

U-30



U-40



U-60



U-90



U-120

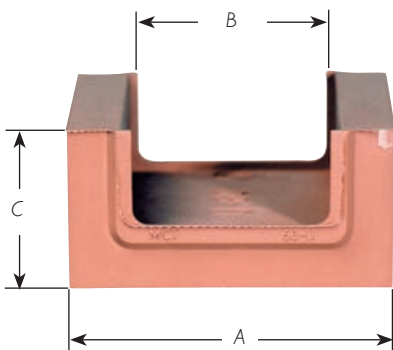

Size	A	B	C
U-30	30	20	15
U-40	40	30	20
U-60	60	40	30
U-90	90	60	45
U-120	120	90	45

This is how U-Blocks are used

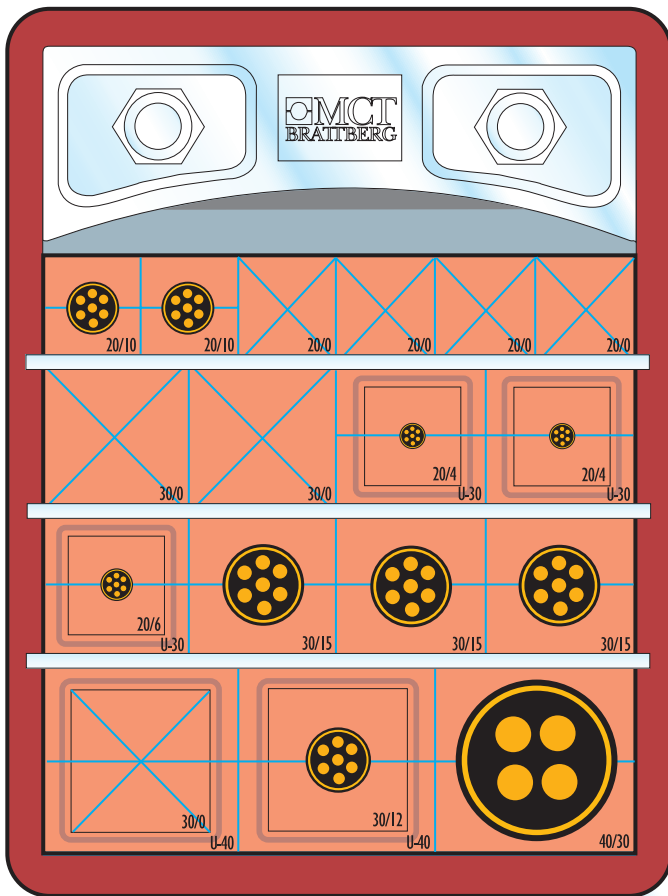

Regardless of cable diameter,
you can retain the outer
measurement of the block
in any row.

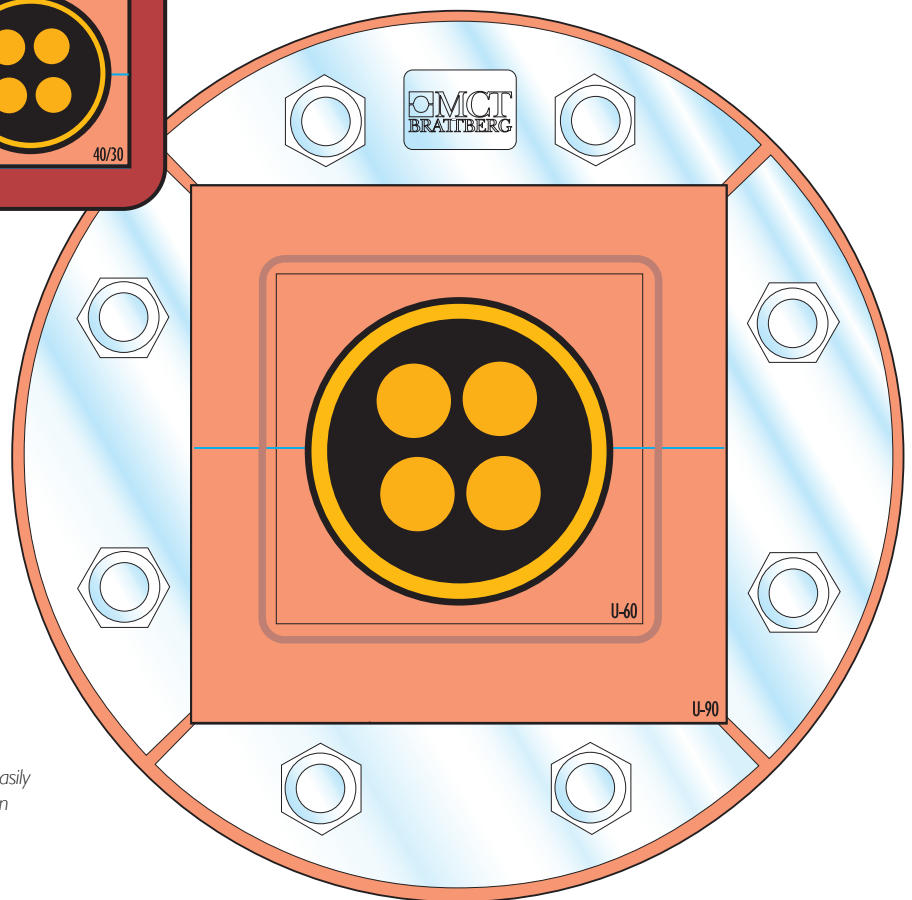

With U-Blocks, you can easily
center the cable or pipe in
your RGP installation.

Welding instructions

Welding method

Shielded metal arc welding (SMAW), Flux Core Arc Welding (FCAW)

Welders qualification

Welders to be qualified according to AWS D1.1 EN 287-1 latest edition or equivalent standard.

Consumable SMAW or FCAW

Consumable to be handled and treated according to manufacturers recommendation.

Preparation and fit

The prepared joint and surrounding areas shall be clean and free from moisture, oil, grease, oxides or any protective coating except weldable primers.

Maximum allowed root gap for fillet welds is 2 mm (see Figure 1).

Preheat and interpass temperature

To avoid hydrogen cracking, joints must be preheated to the temperature shown in the table below.

The minimum preheat temperature must be established for a minimum of 75 mm on either side of the joint. The inter-pass temperature must not exceed 250 °C.

Maximum allowable root gap for fillet joint

Figure 1



Thickness Combined (THC) = $t_1 + t_2$.

If root gap is too wide the deck plate or bulkhead may be built up with weld to achieve a proper gap (see Figure 2).

Build-up of fillet joint

Figure 2

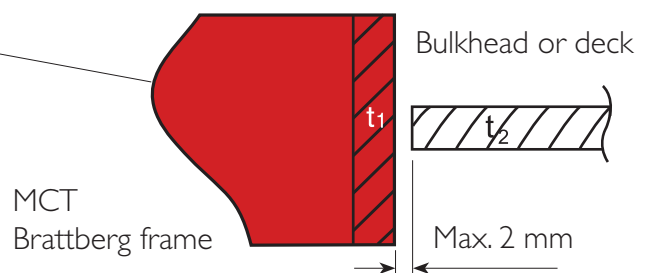

Note! Weld build up on the frame is not recommended as it may cause distortion of the frame.

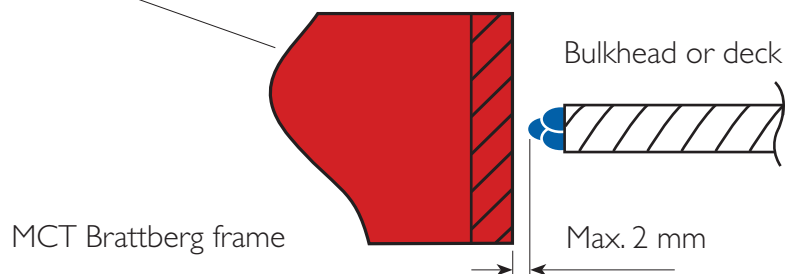

Welding sequence

Welding to be performed according to Figure 3 & 4. Weld pass 3 is not to be started until welds 1 & 2 are completed.

Welding sequence of a two-pass fillet weld

Figure 3

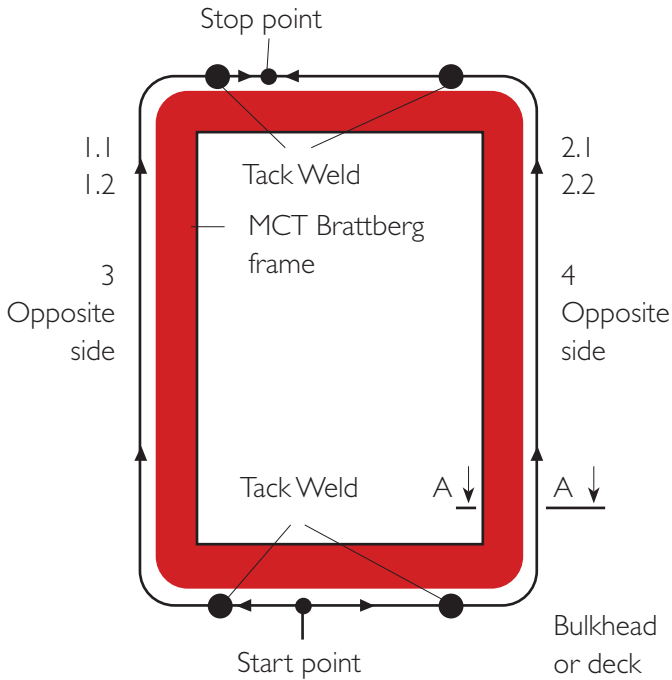

Welding sequence

Figure 4

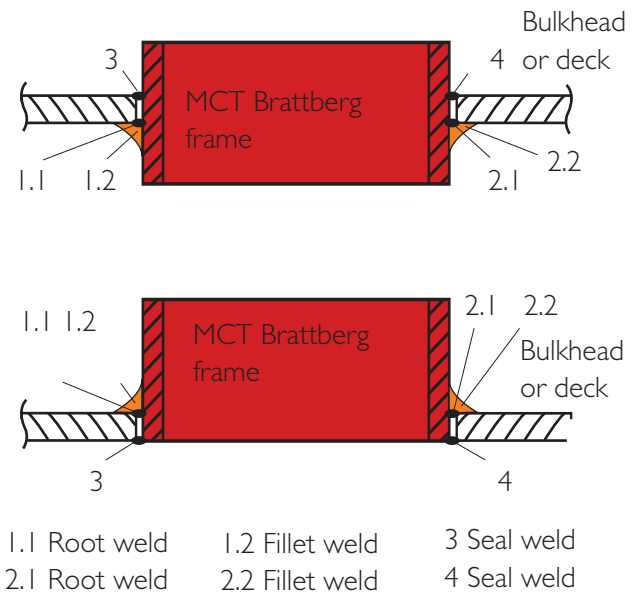

Weld size

Fillet weld size (throat thickness) is to be $0.5 \times$ plate thickness of the bulkhead or deck plate (THD). However fillet weld size is not to be greater than $0.7 \times$ frame plate thickness (THF). See fig 5.

Thus

$$0.5 \times \text{THD} \leq \textcircled{a} \leq 0.7 \times \text{THF}$$

Fillet weld size for a centre-placed frame

Figure 5

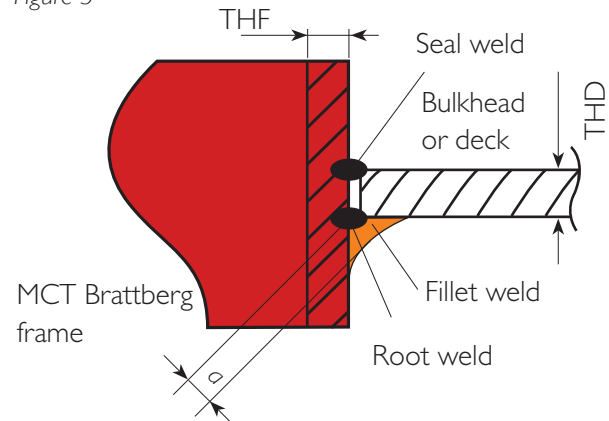

\textcircled{a} = Fillet size (throat thickness) Note!

THD = Thickness deck plate

THF = Thickness frame plate

Multi-pass welding is required if $\textcircled{a} \geq 5 \text{ mm}$

Insulation of bulkheads and decks

In many cases, bulkheads and decks must be insulated with approved A Class or H Class insulation. For A Class this is normally mineral wool, and for H Class this is normally ceramic material or Chartec™.

The recommendations for thickness of insulation to obtain the approved fire class are shown in the diagrams below. The insulation is applied differently depending on which side is considered to be the hazardous side.

STEEL BULKHEADS

Welded frames

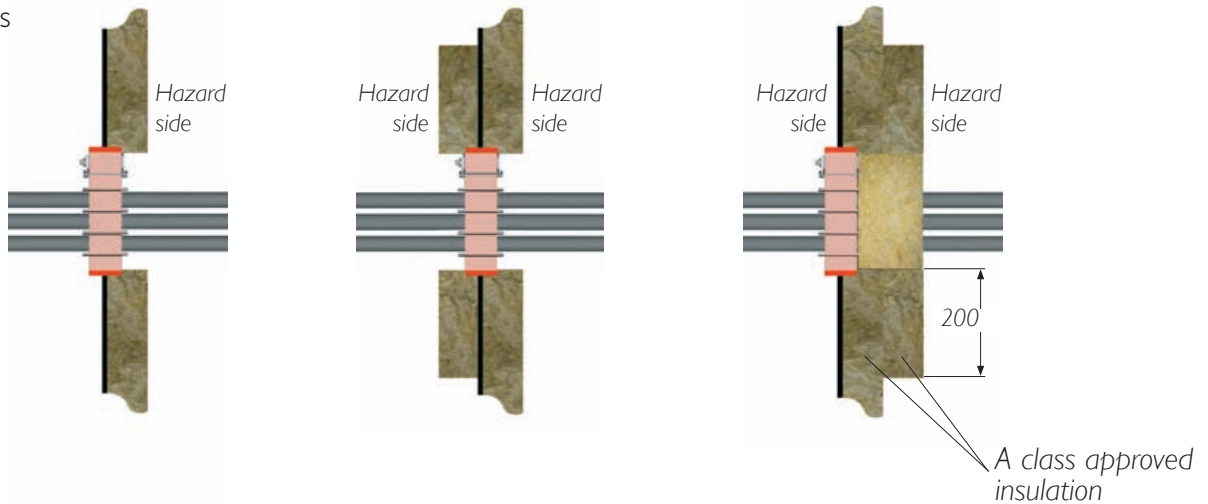

STEEL BULKHEADS

Bolted frames

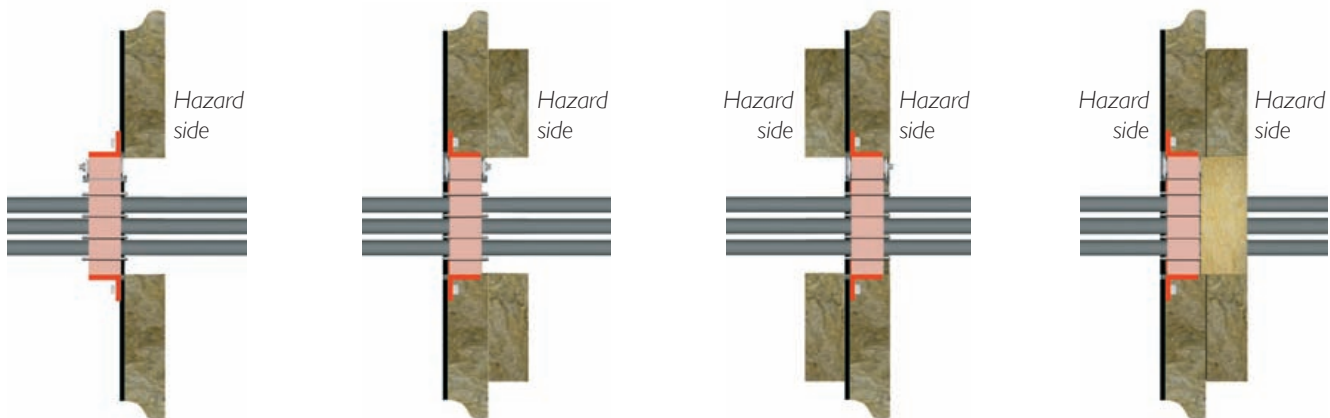

These sketches are for illustrative purposes only. Because of constant system improvements and differences between regulatory authorities, please consult MCT Brattberg for the most current and relevant certified sketches and certificates.

Additional cable transit insulation

The test report and the certificate state whether the transit has to be additionally insulated in part or full in order to comply with the fire class.

Some cable transits do not have the required fire resistance without extra insulation, which has to be applied to parts or the whole face of the transit. It is important to establish exactly which parts have to be insulated. This is stated in the certificate and insulation drawings, of which it is important to receive all the pages.

ALUMINIUM BULKHEADS

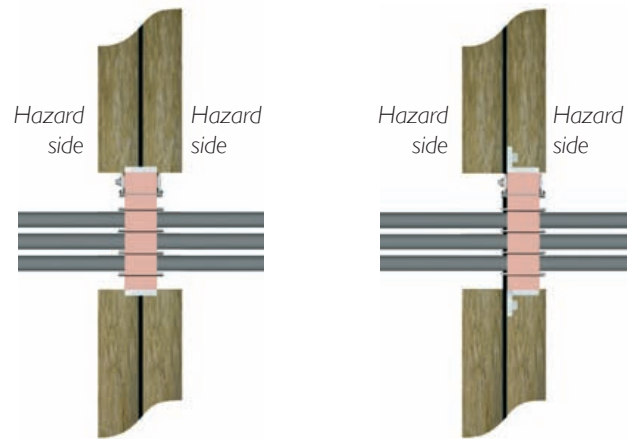

STEEL/ALUMINIUM DECK

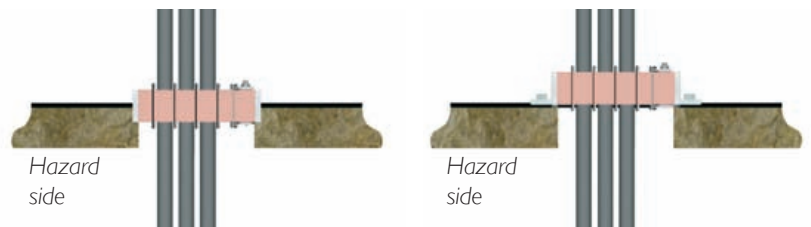

These sketches are for illustrative purposes only. Because of constant system improvements and differences between regulatory authorities, please consult MCT Brattberg for the most current and relevant certified sketches and certificates.

Installation Guide

RGS, RGSR, RGSF, RGSK AND RGSbtb

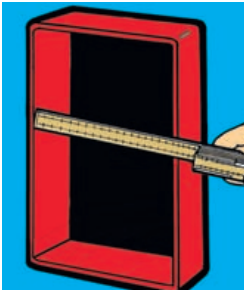

1 Measure the opening to ensure that its size conforms with tolerance standards 120,5 mm ($\pm 0,5$)

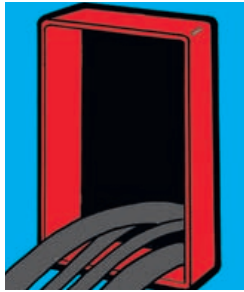

2 Make sure the frame is clean and lubricate the inside of the frame. Then pull cables through, placing the largest at the bottom.



3 Begin packing. A stayplate is inserted between each layer of insert blocks.

PRESSURE APPLICATIONS RGS, RGSC, RGSF, RGSK, RGSR AND RGSbtb

Make sure the frame is clean and lubricate the inside of the frame thoroughly. Lubricate all Lycron parts carefully with the MCT Brattberg lubricant.

Place the compression plate in the centre so that the rubber can come up between the compression plate and the frame on both sides of the plate.

The seal may not be pressurized within 48 hours of installation. This allows for the settlement of the system (based on a 20°C ambient temperature). NOTE. The lower the temperature, the longer the needed settlement time.

Test pressure 5 bar.

NOTE. For pressurized applications, all components must be replaced with new material after removal and refitting.

STG ENDPACKING



4 Insert the compression plate in the frame before the last row of blocks.



5-6 Insert the last row of blocks. Tighten the bolt until there is 32 mm between the top of the plate and the inside of the frame.



7 Insert endpacking STG with the tongue around the compression bolt. Tighten the nuts on the endpacking to compress and complete the seal. Approximately 12 mm of thread should protrude on each bolt.



RGSC

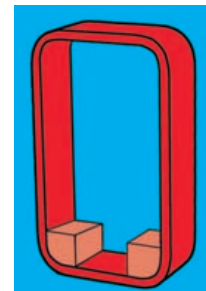

Begin packing with the special corner blocks. Insert endpacking STG with the tongue around the compression bolt. Tighten the nuts on the endpacking to compress and complete the seal. Approximately 12 mm of thread should protrude on each bolt.



PTG PRESSWEDGE

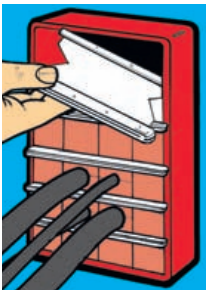

4 Insert the last two stayplates in the frame before the last row of blocks.

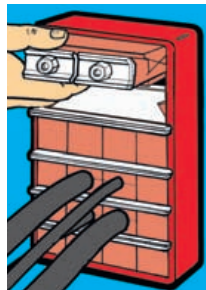

5 Fit first the PTG presswedge at top of the frame. Insert then the last row of blocks.

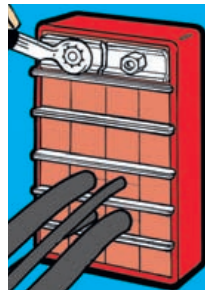

6 Tighten the nuts until about 12 mm of thread protrudes on each bolt.

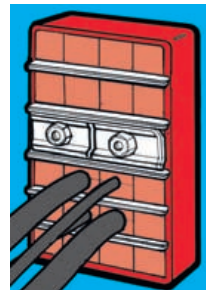

7 The PTG Presswedge can also be placed like this.

RGSC

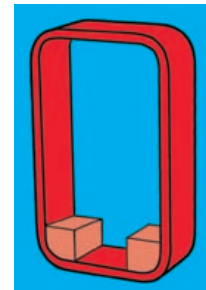

Begin packing using the special corner blocks. Place the PTG presswedge anywhere, except at the top or bottom.

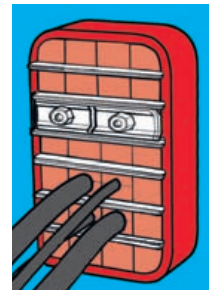

AddBlock

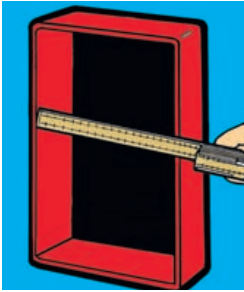

Measure the opening to ensure that its size conforms with tolerance standards 120,5 mm ($\pm 0,5$).



Select a suitable block for the largest cable in the row.



Tear off attached sheet to fit the dimension selected.

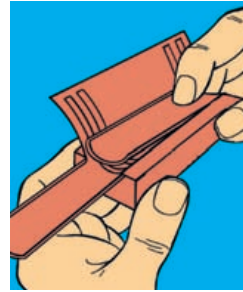

Place sheet into centre slot and affix it with the unique locking device.

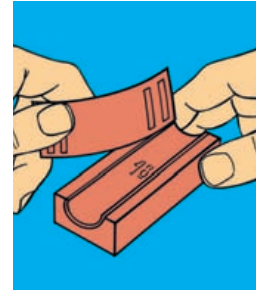

Tear off superfluous sheets.

U-Block

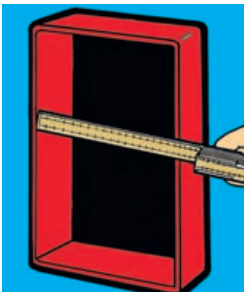

Measure the opening to ensure that its size conforms with tolerance standards 120,5 mm ($\pm 0,5$).

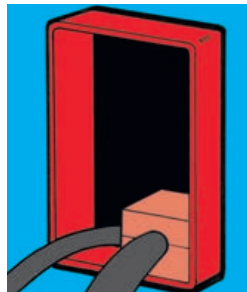

Select a suitable block for the largest cable in the row.

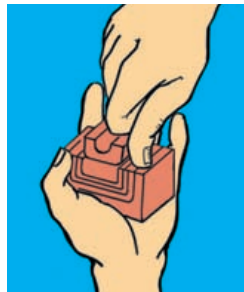

Select a suitable standard Block or AddBlock for the small cable. Then create a base using U-Blocks. The external measurements should be the same as the previous block.

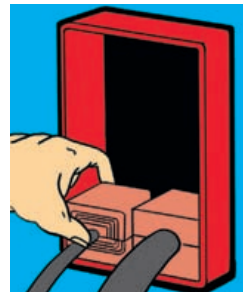

Start packing the frame.



Insert stayplates between each row of insert blocks.

Plug

PREPARING FOR A FUTURE INSTALLATION.



Choose an AddBlock suitable for the cable diameter.

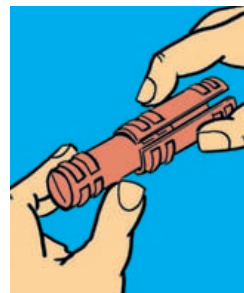

The centre plug is a snug fit for any pre-selected AddBlock since its diameter is adjustable - all thanks to the wraparound casing.



Place the plug in the AddBlock and make sure the locking devices secure it in place.

Horizontal Installation Guide

RGS, RGSF, RGSK, RGSR AND RGSbtb

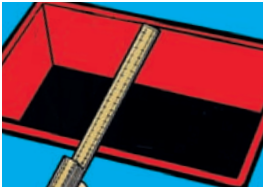

1 Measure the opening to ensure that its size conforms with tolerance standards 120,5 mm ($\pm 0,5$).

3 In horizontal installations, gravity makes it necessary to use the stayplates to hold the insert blocks in place. Therefore, place the stayplates in the frame first, dividing up the rows of cables according to your RG-plan. Also insert the compression plate at this stage.

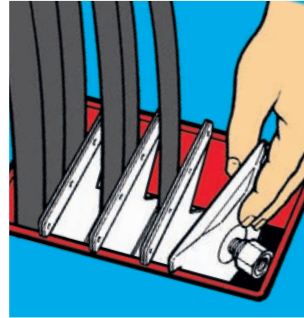

2 Make sure the frame is clean, then lubricate the inside and pull the cables through, placing the largest farthest from the compression plate.



5 Pack the last row, then tighten the bolt on the compression plate counter-clockwise until there is 32 mm of space between the top of the plate and the frame or enough to fit the endpacking tongue around the bolt.

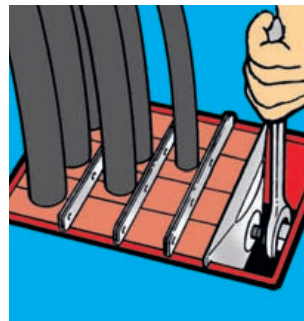

4 Insert the outer blocks first (A, B, C etc.). Then insert the remaining blocks. Note. The block A should be turned 90°, as shown in the picture.

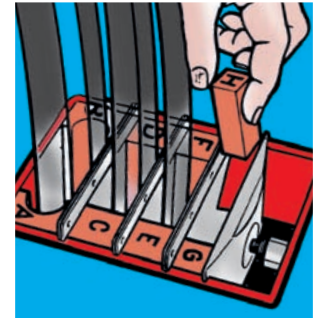

6 Insert endpacking STG with the tongue around the compression bolt. Tighten the nuts on the endpacking to compress and complete the seal. Approximately 12 mm of thread should protrude on each bolt.

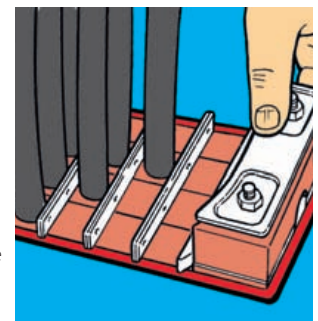

Disassembly Guide

STG

1 Remove the nuts and the hardware from the face of the endpacking.

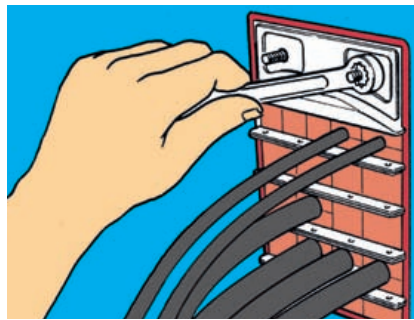

2 Attach the endpacking puller to the bolts with the nuts from the endpacking.

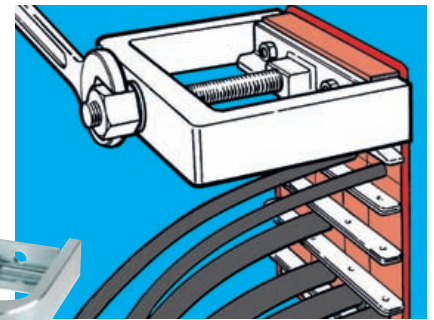
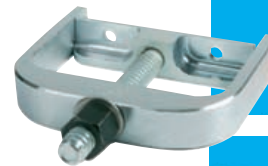

3 Tighten the bolt on the puller and the endpacking slides out.

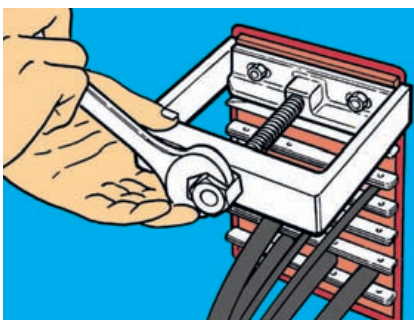

4 Remove the endpacking.

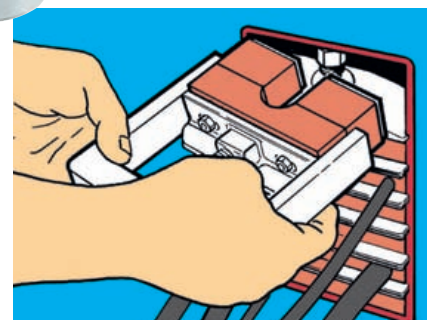

RGP Installation Guide

1

Measure the opening to ensure that its size conforms with tolerance standards (+2 - 0 mm).

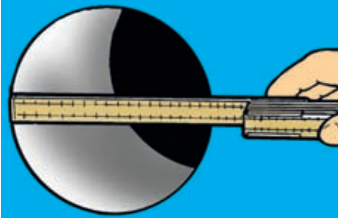

2

Insert the RGP frame in the opening. No lubricant should be applied to the hole or to the outside of the frame.

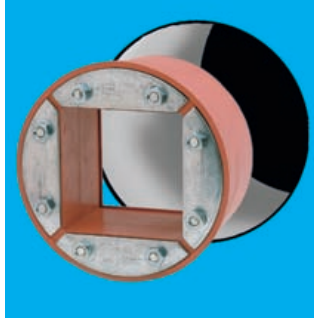

3

Pull the cables through, placing the largest at the bottom of the frame.

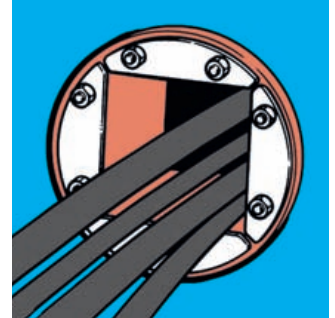

4

Begin packing.

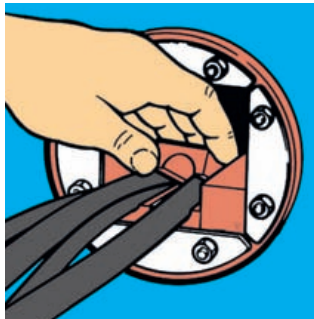

5

Tighten the bolts to compress and complete the seal. Approximately 10 to 12 mm of thread should protrude on each bolt.

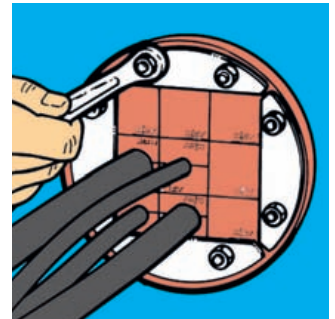

PRESSURE APPLICATIONS RGP

Clean the inside of the pipe and the outside of the RGP prior to installation, but apply no lubricant to either surface.

Lubricate all the Lycron parts carefully with the MCT Brattberg lubricant.

The RGP seal may not be pressurized within 48 hours of installation - this allows for the settlement of the system (based on a 20°C ambient temperature). NOTE. The lower the temperature, the longer the needed settlement time.

Test pressure 4.5 bar; In the case of higher pressure, please contact MCT Brattberg.

NOTE. For pressurized applications, all components must be replaced after removal and refitting.



www.mctbrattberg.com

MCT Brattberg AB
SE-371 92 Karlskrona
Sweden
Phone: +46-455 37 52 00
Fax: +46-455 37 52 90
E-mail: info@mctbrattberg.se
Website: www.mctbrattberg.se

MCT Brattberg Ltd
Commerce Street
Carrs Industrial Estate Haslingden
Lancashire BB4 5JT
England
Tel: +44 - 170 624 4890
Fax: +44 - 170 624 4891
E-mail: info@mctbrattberg.co.uk

MCT Brattberg Inc.
P.O. Box 374
Spring Tx 77383
Visiting address:
3332 Spring Stuebner Rd
Suite E, Spring TX 77389
USA
Phone: +1 (281) 355 8191
Fax: +1 (281) 355 8393
E-mail: info@brattberginc.com

We have representatives in:

*Austria - Australia - Brazil - Canada - China - Croatia - Denmark - Egypt - Finland - France - Germany - Greece - Hong Kong - Iceland - India
Indonesia - Iran - Ireland - Israel - Italy - Japan - Korea - Malaysia - Netherlands - New Zealand - Norway - Oman - Philippine Islands - Poland - Qatar
Romania - Russia - Singapore - Spain - South Africa - Switzerland - Taiwan - Turkey - Thailand - UAE - Ukraine - United Kingdom - USA*

Visit our website or contact MCT Brattberg for details of your nearest distributor.